



tempio[®] BAGUETTE

SUNSCREEN SYSTEMS | SISTEMA DE LAMAS CERÁMICAS

TERRACOTTA & GLAZED SUNSCREENS

PAREDES DE BAGUETE

tempio®

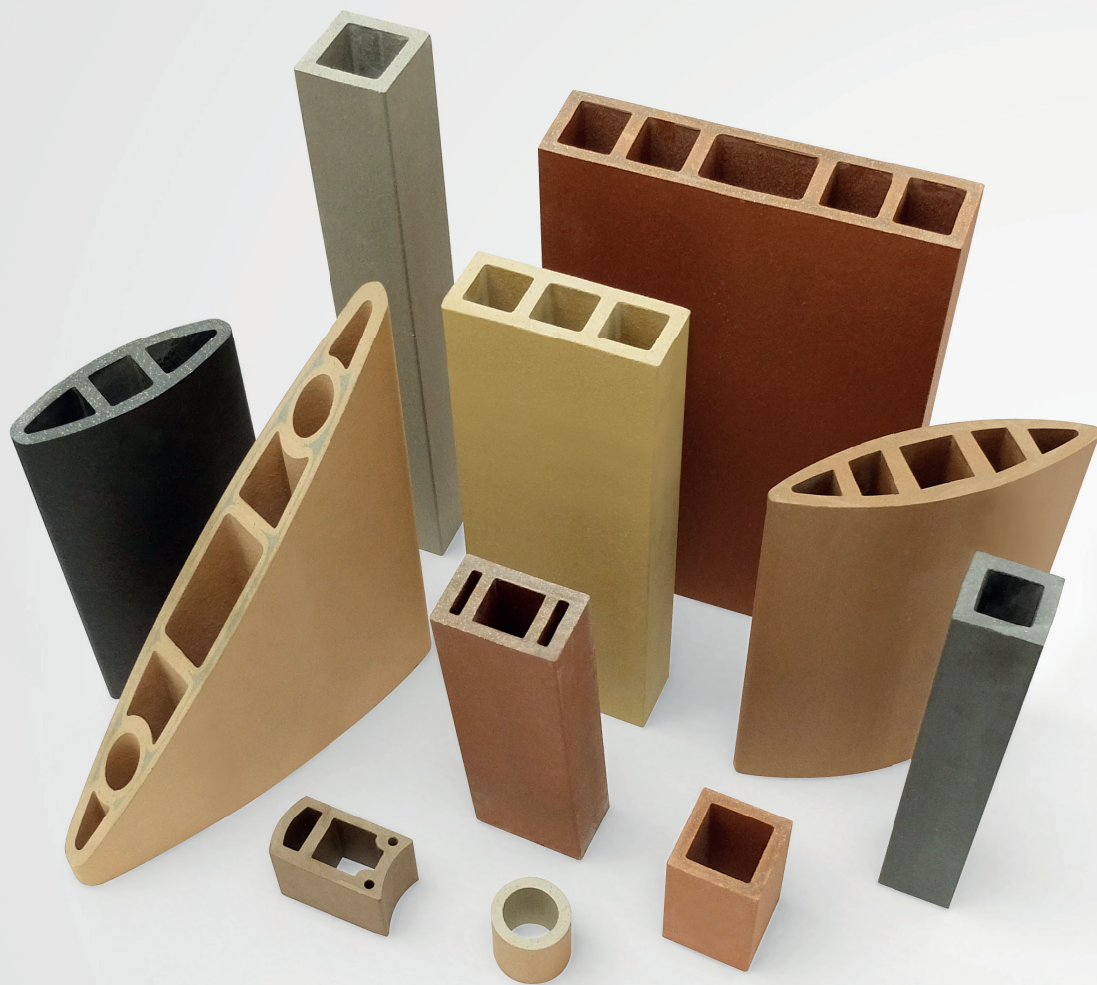

Solar shading
Protección solar

Horizontal and vertical element orientation
Orientación elemento horizontal y vertical

Suitable for any building size
Apto para cualquier tamaño del edificio

Venetian blind slats with Ceramics
Celosía con lamas de Cerámica

Window sill and wall copings
Alfeizares de ventanas y coronación de paredes

Profiles with hollow chambers
Perfiles con cámaras huecas

Customized designed substructure
Subestructura especialmente diseñada

Wide variety of terracotta colours and glazed colours with gloss or matt finish. On request, other finishing colors can be produced.

Gran variedad de colores naturales y esmaltados brillo o mate. También fabricamos colores bajo demanda.

Customized pieces
Piezas a medida









tempio





Advantages for façade in safety, comfort and aesthetics

Ventajas para fachada en seguridad confort y estética



EXCELLENT ISOLATION PROTECCIÓN AISLANTE

-  **Energetic costs 25-40% reduction**
_ Reducción entre 25-40% del gasto energético
-  **Increased thermal and acoustic comfort**
_ Aumento del confort térmico y acústico
-  **No water condensation**
_ Eliminación del agua de condensación
-  **Waterproof building**
_ Impermeabilidad del edificio
-  **Passive ventilation**
_ Ventilación pasiva
-  **Thermal isolation**
_ Aislante térmico
-  **Double wall**
_ Doble pared





SUSTAINABLE SOSTENIBLE

-  **0% wastewater discharged**
_ 0% de aguas residuales vertidas
-  **Low CO2 emissions**
_ Mínima emisión de CO₂
-  **Waste material recycling**
_ Reciclaje del material sobrante

LONG LIFE PRODUCT PRODUCTO DE LARGA VIDA

-  **Unalterable colours**
_ Colores inalterables al paso del tiempo
-  **Self-cleaning with rainwater**
_ Autolimpiable con agua de lluvia
-  **Time resistant**
_ Resistente al paso del tiempo

REHABILITATION REHABILITACIÓN

-  **Direct application without creating debris**
_ Aplicación directa sin crear escombros
-  **Piece by piece replaceable system**
_ Sistema reemplazable pieza por pieza
-  **Revaluation of property**
_ Revalorización del inmueble
-  **Hidden conductions**
_ Paso de conducciones no vistas
-  **Hidden cracks and crevices**
_ Grietas ocultas





PROJECT
Abercrombie Building
University of Sydney Business School

LOCATION
Darlington, Australia

ARCHITECT
Woods Bagot/Kann Finch

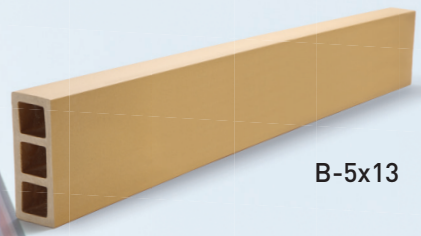

CONTRACTOR
John Holland

PIECE

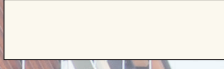
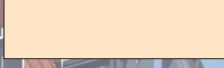
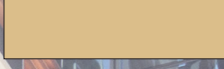

B-5x13

COLOURS

-  White Formentera EB3210
-  Blanco W2-07
-  Amarillo Y125-15
-  Rojo R05-05
-  Rojo R25-25





PROJECT
Biological Science Building
University Of New South Wales (UNSW)

LOCATION
Sydney, Australia

ARCHITECT
Woods Bagot, John Norman

CONTRACTOR
Sharvain Projects

PIECE



FK-20



B-5x5
B-6x25

COLOURS

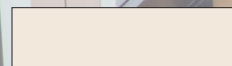

Blanco W00-20

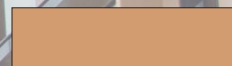

Naranja NA05-05



Rojo R15-10

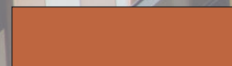

Rojo R25-19

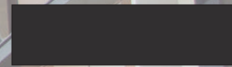

Negro B5-10



PROJECT

UNSW University of new South Wales Sydney

LOCATION

FJMT Sydney (Mathew Todd & Janine Deshon)

ARCHITECT

Installation Company Yuanda

Construction Company Brookfield Multiplex

CONTRACTOR

John Holland

PIECES



FKL2-16/300



FBV1/24



BO-300x62

COLOURS

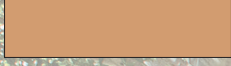

Orange NA05-15





PROJECT
Kuntola School

LOCATION
Järvenpää, Finland

ARCHITECT
Kirsti Sivén & Asko Takala

PIECE

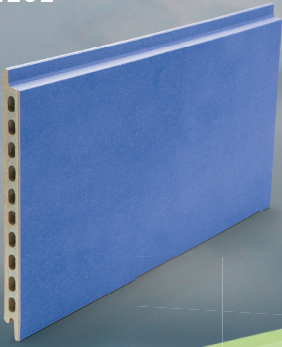

FS-20



B-5x13

COLOURS



Green Exeter EB3415

Green Glasgow EB3470



Violet Medellin EB3980

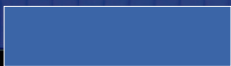

Blue Mediterraneo EB3360





PROJECT
Doosan Leadership Institute

LOCATION
Seoul, South Korea

ARCHITECT
Park Gene, AI Architects

CONTRACTOR
Sunpark

PIECE



FK-L1/16-400

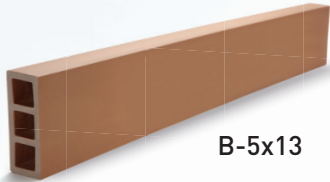

B-5x13

COLOURS



Marrón BR2-08

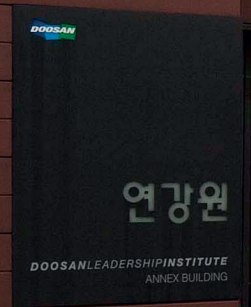



tempio® BAGUETTE

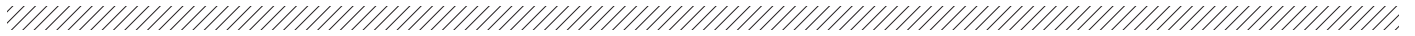

B-d50

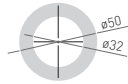

B-5x5 curvo

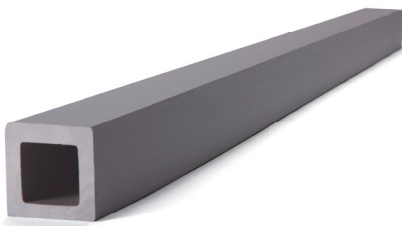
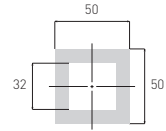

B-5x5

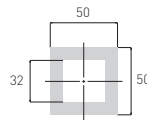

B-6x6

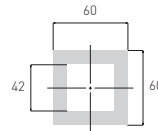

B-7x7

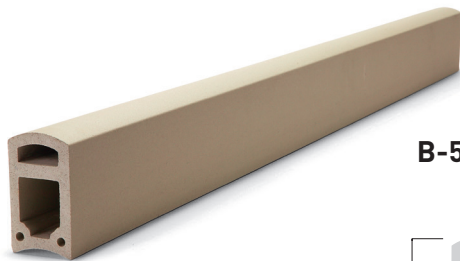
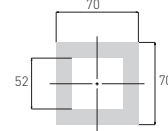

B-5x8 r50

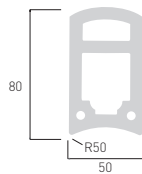

B-5x8

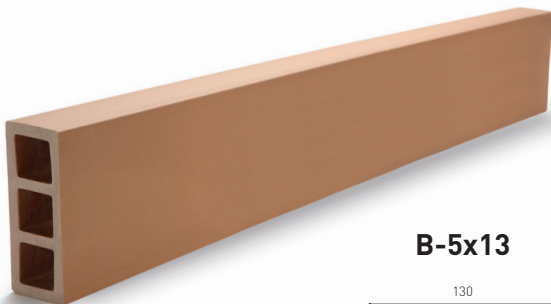
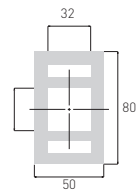

B-5x13

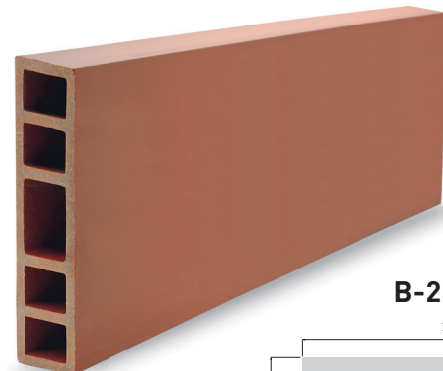
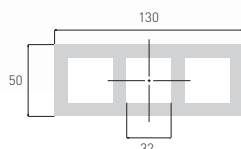

B-250x60

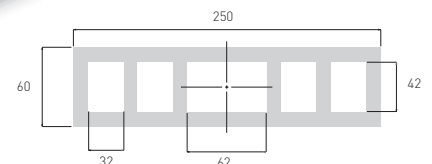

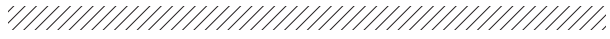

BO-160x50

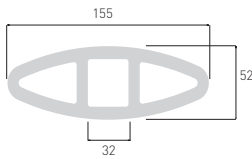

BO-200x50

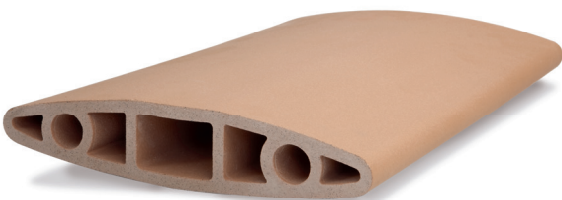
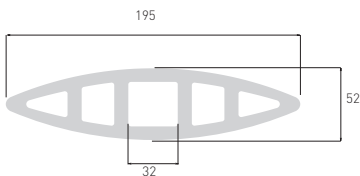

BO-300x62

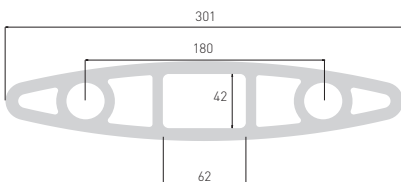

Size guide Guía de medidas

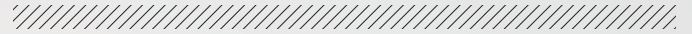

piece / pieza	length piece largo pieza	weight / peso kg/m lineal
B-d50	< 1800 mm	2,5
B-d110	< 1500 mm	2,5
B-5x5	< 1800 mm	3,5
B-6x6	< 1800 mm	4
B-7x7	< 1800 mm	5
B-5x5 curve	< 600 mm	3,5
B-5x8	< 1800 mm	5,5
B-5x8 r50	< 1800 mm	5,5
B-5x13	< 1800 mm	7,7
B-6X25	< 1800 mm	15
BO-5x16	< 1500 mm	7,6
BO-5x20	< 1500 mm	9,7
BO-6,2x30	< 1500 mm	17,5

Profiles with hollow chambers
Perfiles con cámaras huecas

Specially designed substructure
Subestructura especialmente diseñada



Special projects Proyectos especiales



Made-to-measure on request
Fabricación a medida bajo demanda

Special Cuts
Cortes especiales

Colour development for projects
Desarrollo de colores especiales
para proyectos



SWING SYSTEMS

HORIZONTAL SYSTEM



VERTICAL SYSTEM

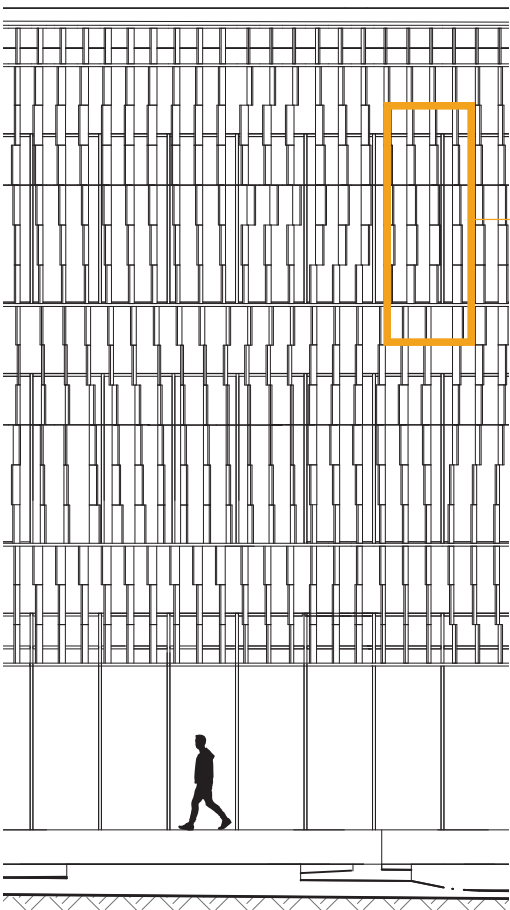

Swing System
Sistema de giro

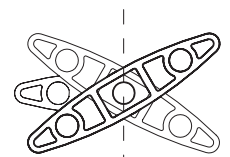
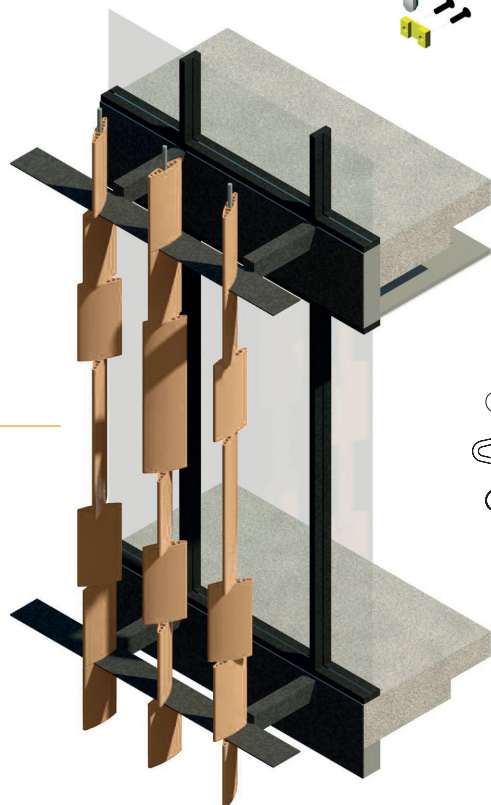
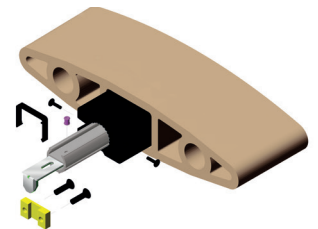



tempio®

Façade & sunscreen colour palette

Colores para fachada y baguette

This is the chart of natural and enamel tones, matte and gloss, that we present. We can also create a custom color. We seek the homogeneity of the entire surface of each piece and of the entire façade. The quality of our ceramics makes it remain unchanged over the years or in environmental conditions.

Esta es la carta de tonos naturales y esmaltados, mate y brillo, que presentamos. También podemos crear un color personalizado. Buscamos la homogeneidad de toda la superficie de cada pieza y del total de la fachada. La calidad de nuestra cerámica hace que permanezca inalterable con el paso de los años o las condiciones ambientales.

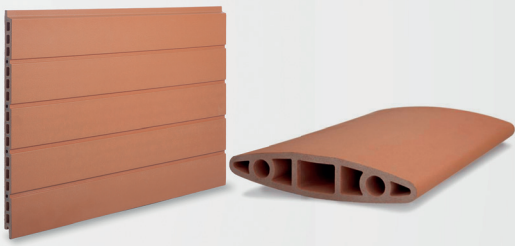

*Colours may suffer variations in tone

* Los colores pueden sufrir variaciones de tonalidad

NATURAL

 <p>Blanco W00-20</p>	 <p>Blanco W2-07</p>	 <p>Amarillo Y00-05</p>
 <p>Amarillo Y125-15</p>	 <p>Amarillo Y05-02</p>	 <p>Naranja NA05-05</p>
 <p>Naranja NA05-15</p>	 <p>Rojo R05-05</p>	 <p>Rojo R15-10</p>
 <p>Rojo R25-19</p>	 <p>Rojo R25-25</p>	 <p>Marrón BR2-08</p>
 <p>Gris GR1-10</p>	 <p>Gris GR02-20</p>	 <p>Negro B5-10</p>

MATT
MATE
SATIN
SATINADO
GLOSS
BRILLO

White Madrid EM2220

White Sevilla ES4220

White Formentera EB3210

Yellow Tanzania EB3660

Yellow Angola EB3680

White Palma EM2230

White Palma ES4230

White Palma EB3230

Red Murano EB3550

Violet Nicaragua EB3985

Marfil Barcelona EM2250

Marfil ES4250

Grey Foster EB3123

Violet Monterrey EB3950

Violet Guadalajara EB3990

Grey Foster EM2123

Grey Foster ES4123

Grey Arcadia EB3155

Blue Orinoco EB3370

Blue Nilo EB3390

Grey Arcadia EM2155

Grey Arcadia ES4155

Grey Princeton EB3182

Blue Volga EB3315

Green York EB3495

Grey Princeton EM2182

Grey Princeton ES4182

Black Columbia EB3187

Green Surrey EB3460

Green Leicester EB3480

Black Columbia EM2187

Black Columbia ES4187



Specially designed substructure
Subestructura especialmente diseñada

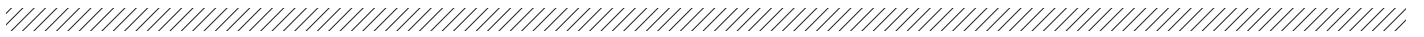

HORIZONTAL SYSTEMS

ANCHOR PLATE SYSTEM

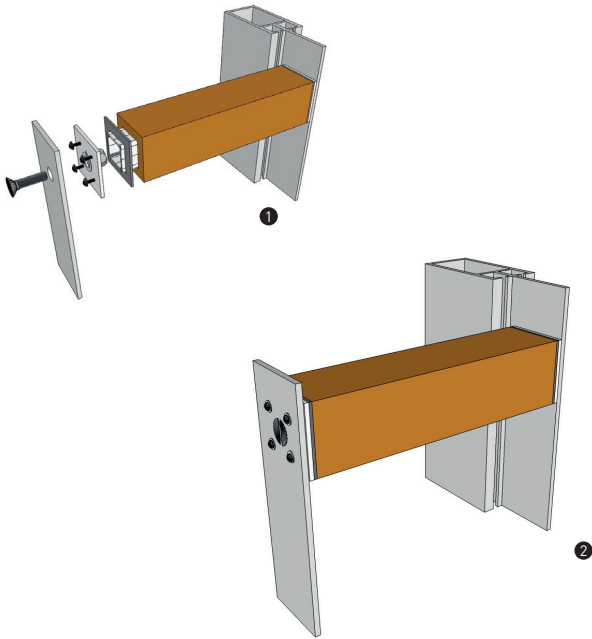

STANDARD SYSTEM

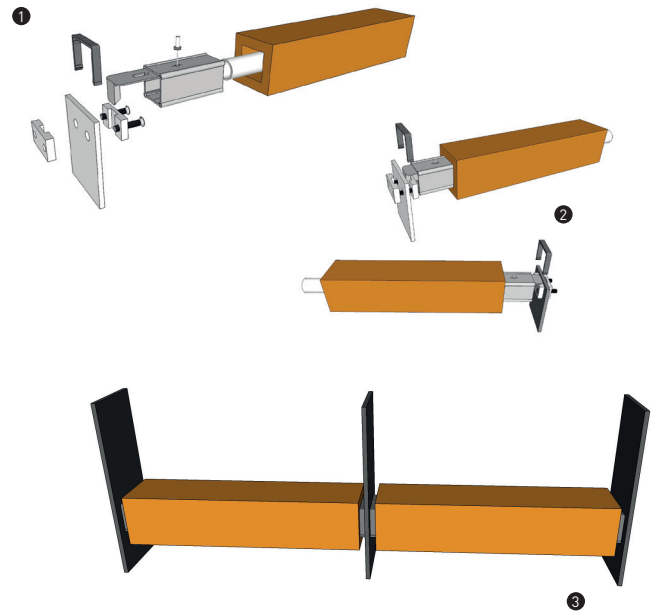

VERTICAL SYSTEMS

POP NUT SYSTEM

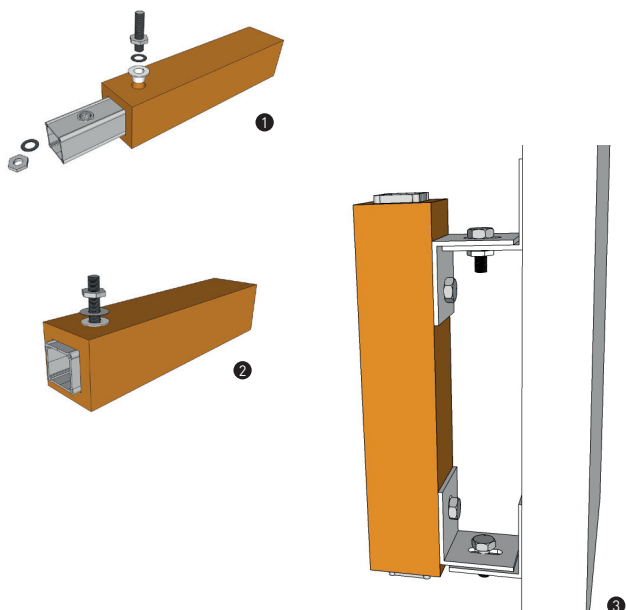

HOOK SYSTEM

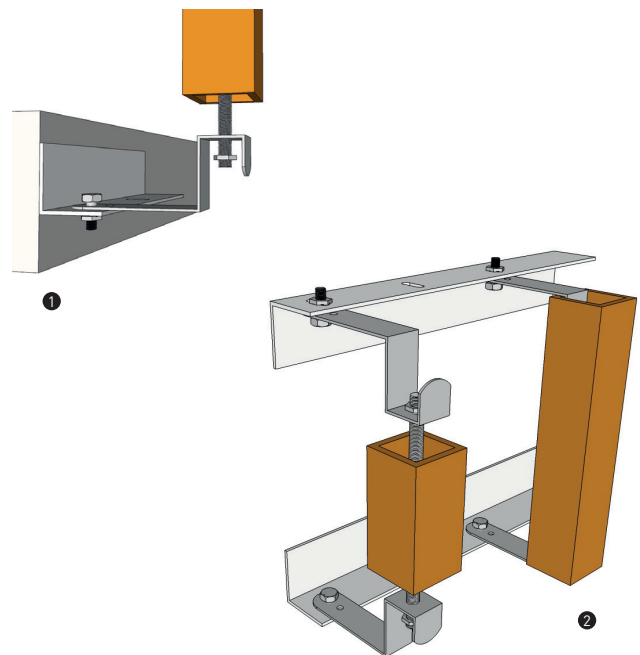



INTERIOR & DESIGN
INTERIORES Y DISEÑO



Fluidity Exhibition. Valencia, Spain.



Ambient separation
Separación de ambientes

Coating for interior walls and ceilings
Revestimiento de techos y paredes interiores

Ephemeral architecture
Arquitectura efímera

tempio®



Primavera Hotel. Benidorm, Spain.

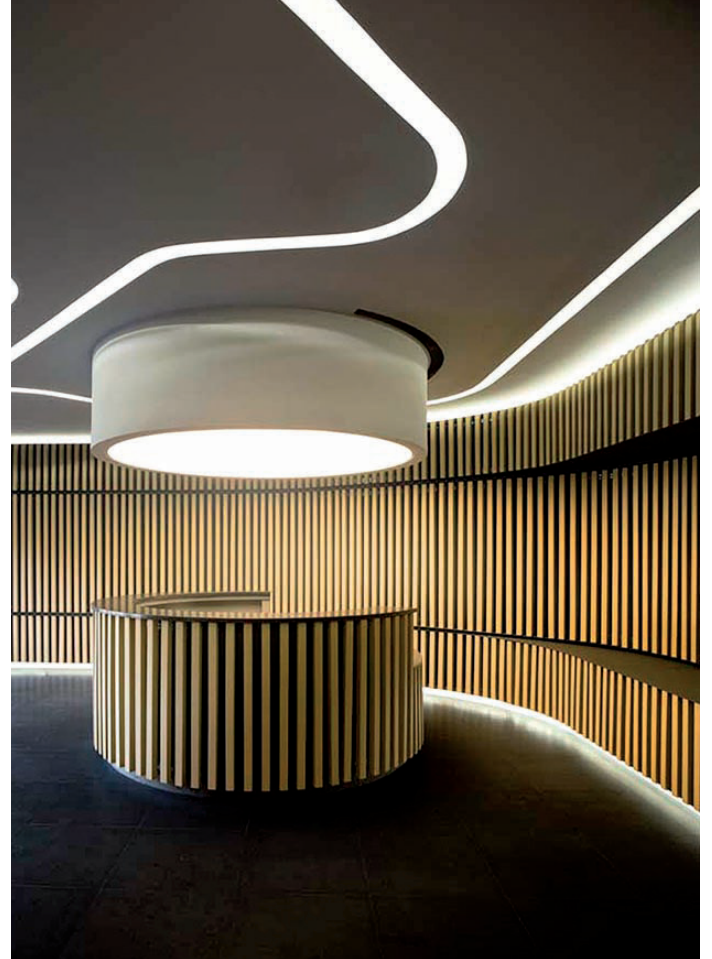

Príncipe de Vergara. Madrid, Spain.

UNSW University of new South Sales Sydney



EDITION - APR'20

tempio®

CERÁMICA MAYOR, S.A.
Partida Planet, s/n
03510 Callosa d'En Sarrià
(Alicante-España)

T+34 965 881 175
www.ceramicamayor.com
www.tempio.es

www.tempio.es