



FS SYSTEM

Technical brochure
Folleto técnico

tempio[®]

INDEX

Perspectives 3
Perspectivas

Constructive details 9
Detalles constructivos

Pieces catalogue
Catálogo de piezas

FS-20 20

FS-24 23

FS-30 25

FS-L 2/20 27

FS-L 3/30 28

FS-L 4/24 29

FS-L 5/30 30

FS-L 7/30 31

FS-LP 2/30 32

FS-LP 3/30 33

FS-2B 5/30 34

FS-T 7/28 35



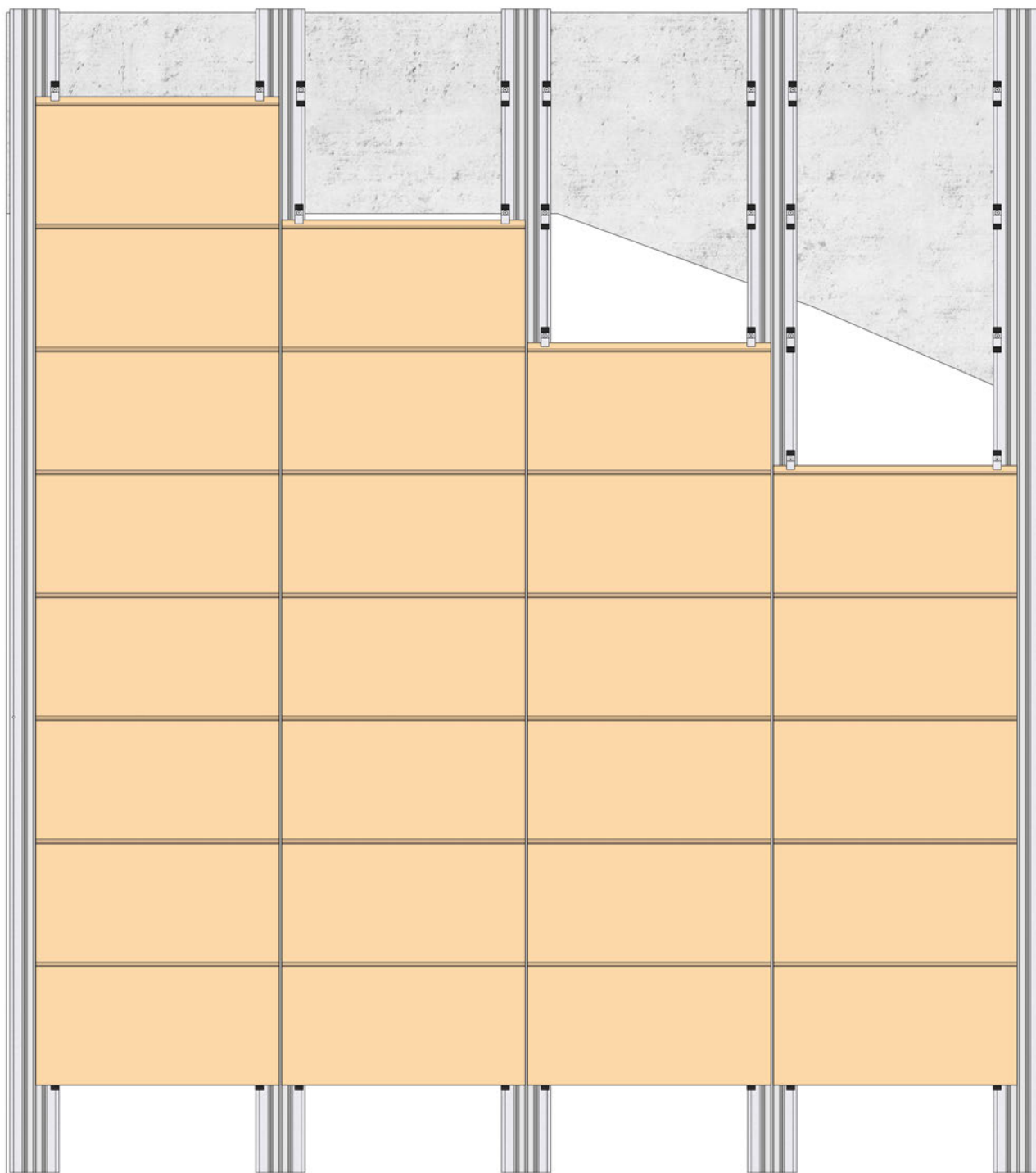

FS SYSTEM

System front view

Vista frontal del sistema

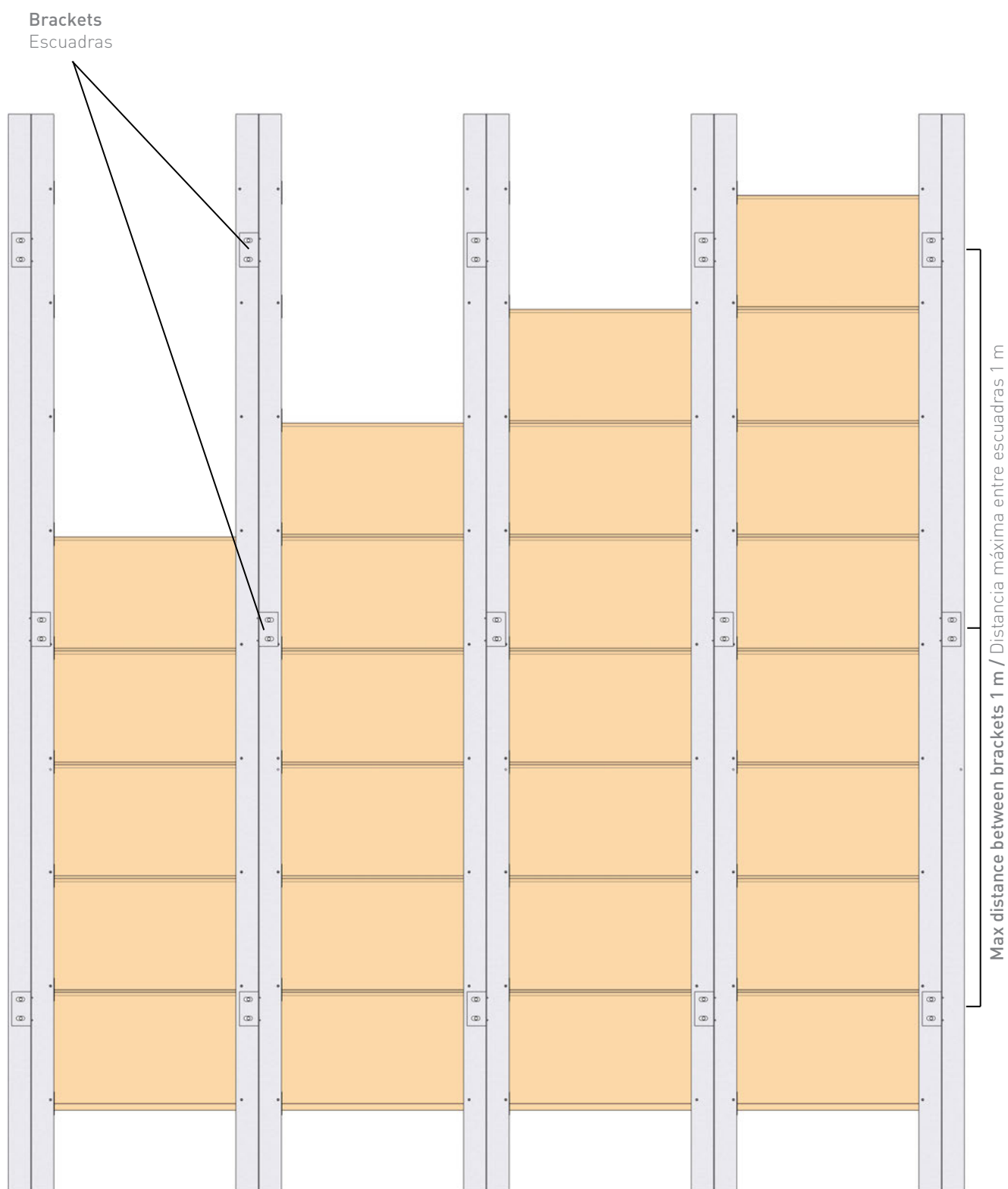

FS SYSTEM

System back view

Vista posterior del sistema

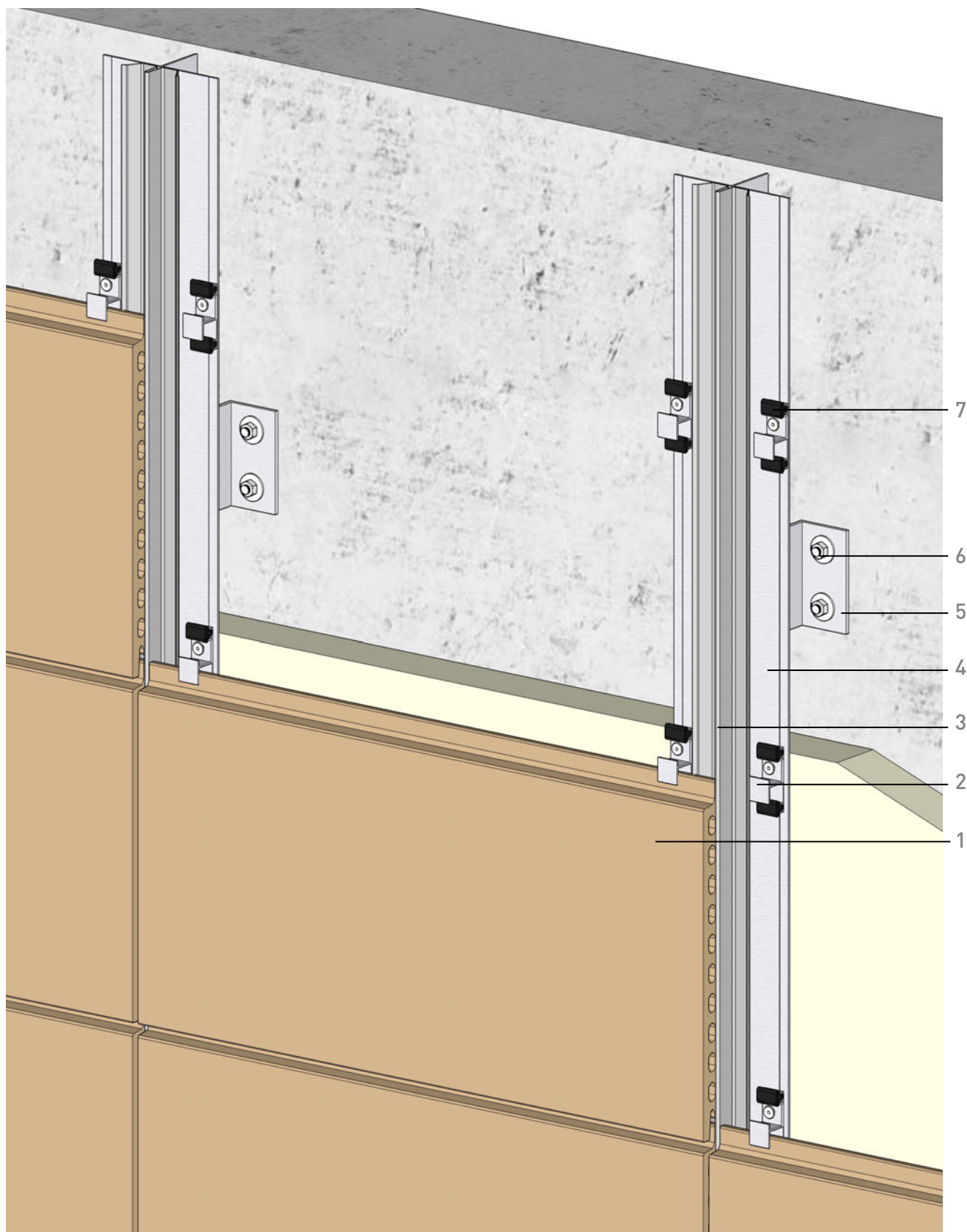

- 1. Tempio tile
Pieza Tempio
- 2. Clip
Grapa
- 3. Vertical joint profile
Perfil vertical de junta
- 4. Main T profile
Perfil T

- 5. Bracket
Ménsula
- 6. Anchorage
Anclaje
- 7. Anti-vibration rubber
Goma antivibración

FS SYSTEM

Perspective

Perspectiva

tempio®

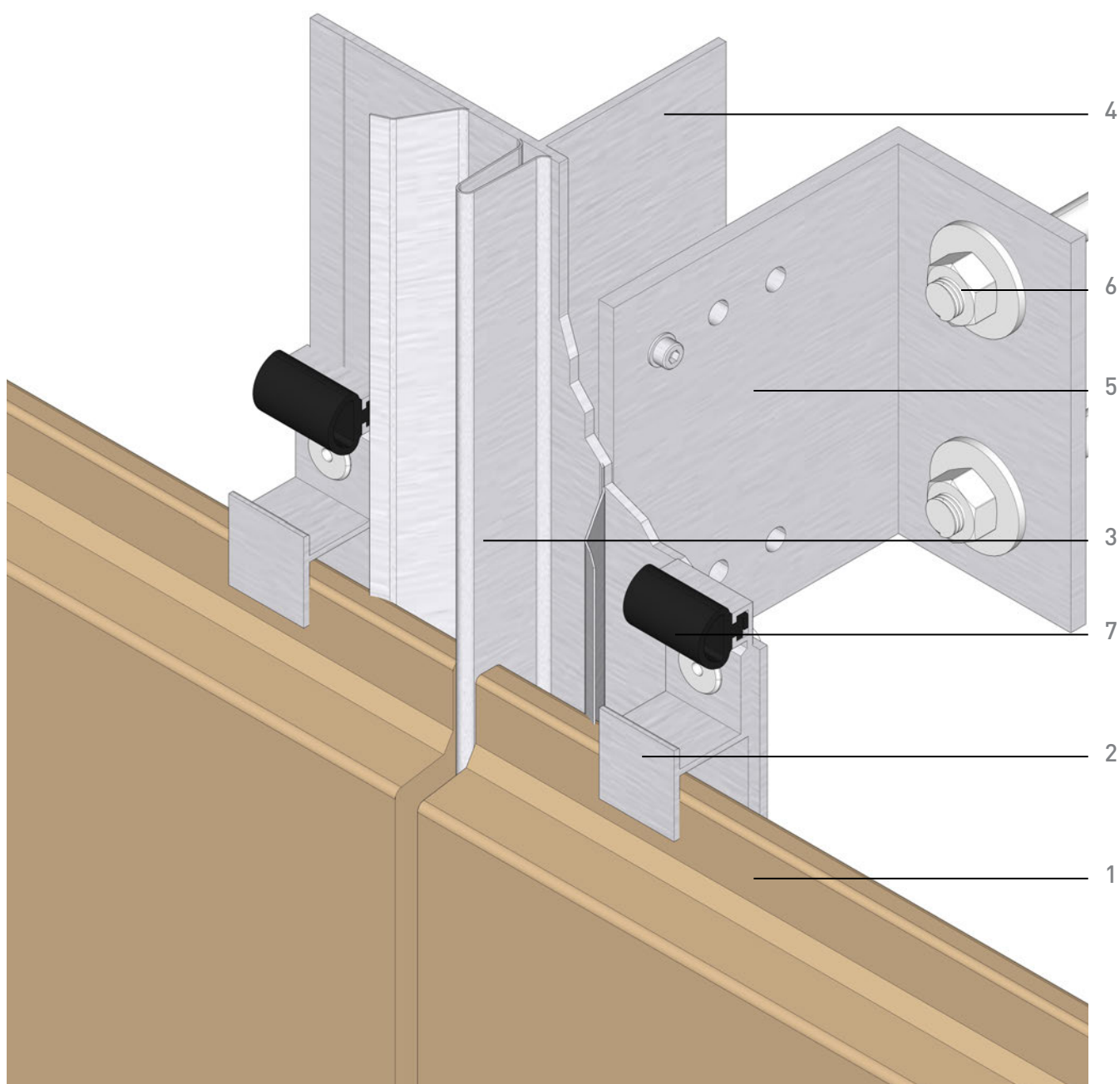

- 1. Tempio tile
Pieza Tempio
- 2. Clip
Grapa
- 3. Vertical joint profile
Perfil vertical de junta
- 4. Main T profile
Perfil T

- 5. Bracket
Ménsula
- 6. Anchorage
Anclaje
- 7. Anti-vibration rubber
Goma antivibración

FS SYSTEM

Joint detail

Detalle de junta

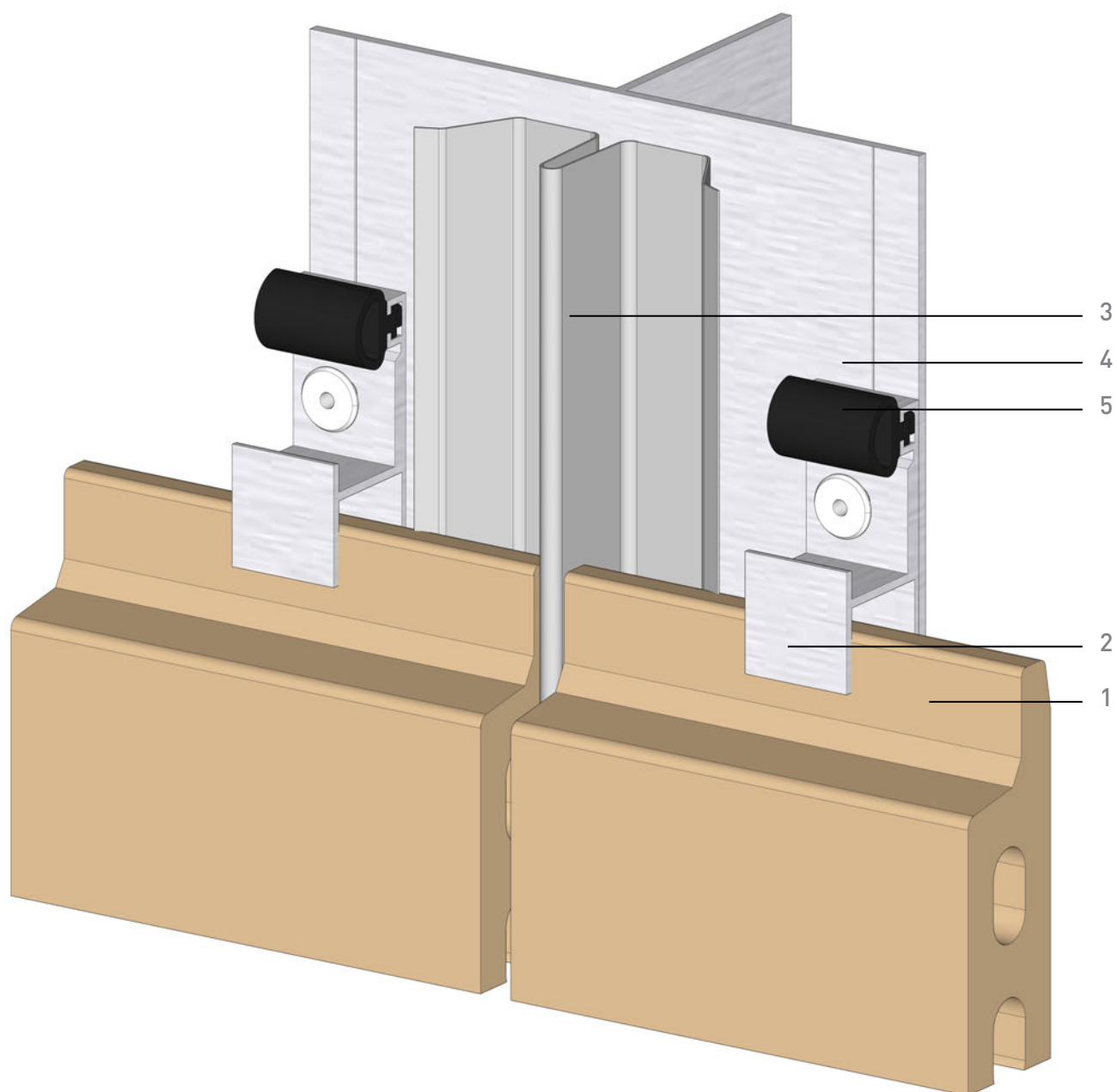

- 1. Tempio tile
Pieza Tempio
- 2. Clip
Grapa
- 3. Vertical joint profile
Perfil vertical de junta

- 4. Main T profile
Perfil T
- 5. Anti-vibration rubber
Goma antivibración

FS SYSTEM

Joint detail

Detalle de junta

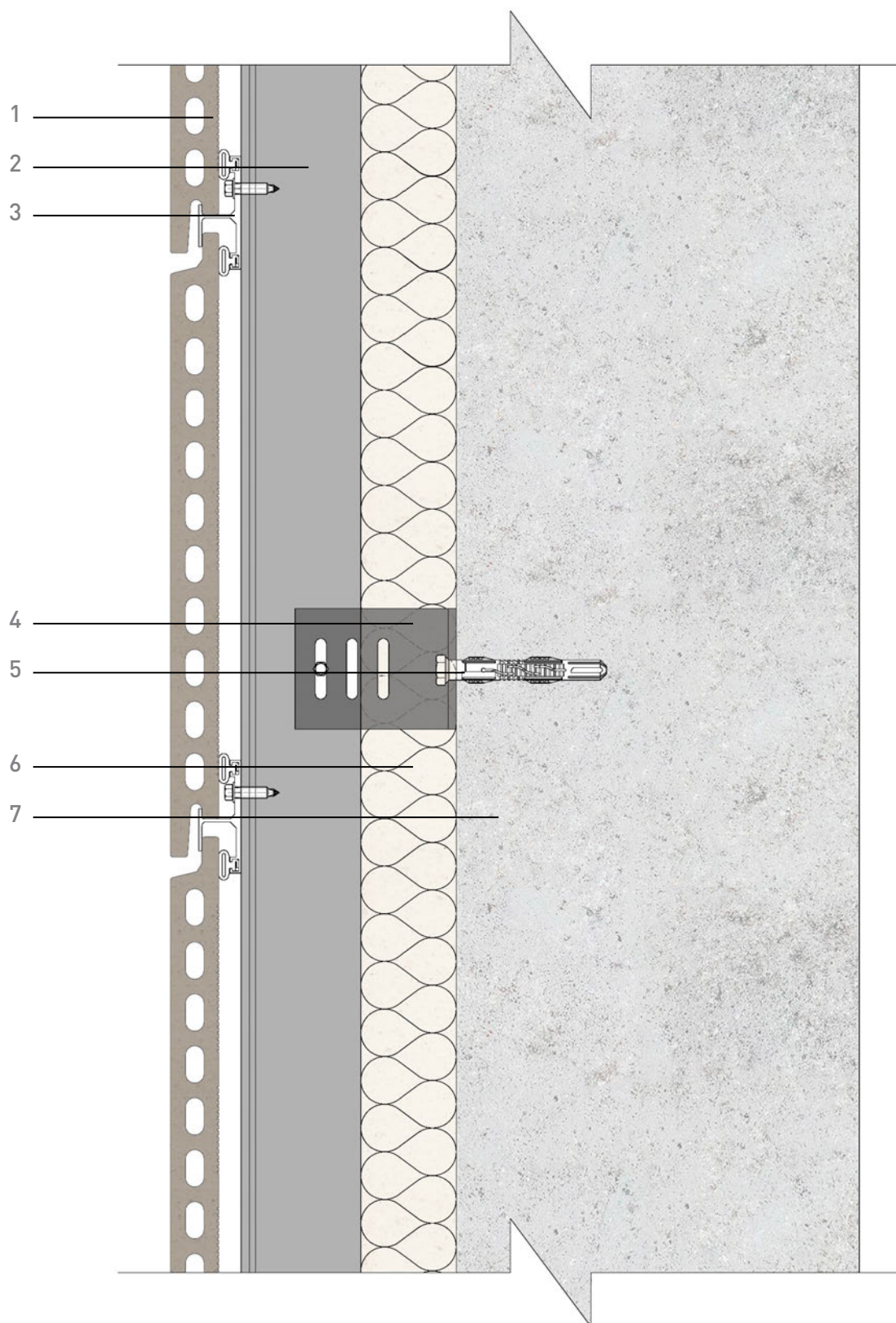

- | | |
|--|---------------------------------|
| 1. Tempio tile
Pieza Tempio | 5. Anchorage
Anclaje |
| 2. Vertical T profile
Perfil T vertical | 6. Insulating layer
Aislante |
| 3. Clip
Grapa | 7. Wall
Muro |
| 4. Bracket
Ménsula | |

FS SYSTEM

Vertical section

Sección vertical

tempio®

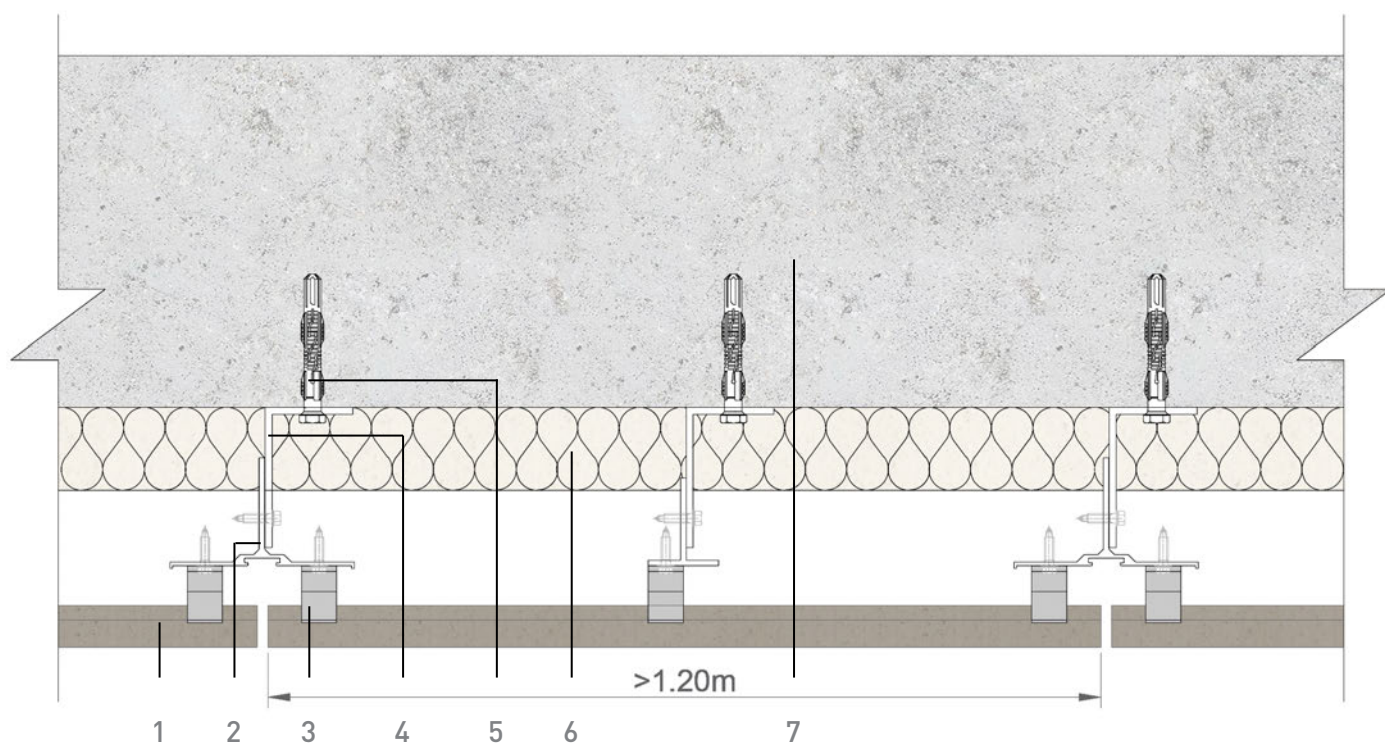
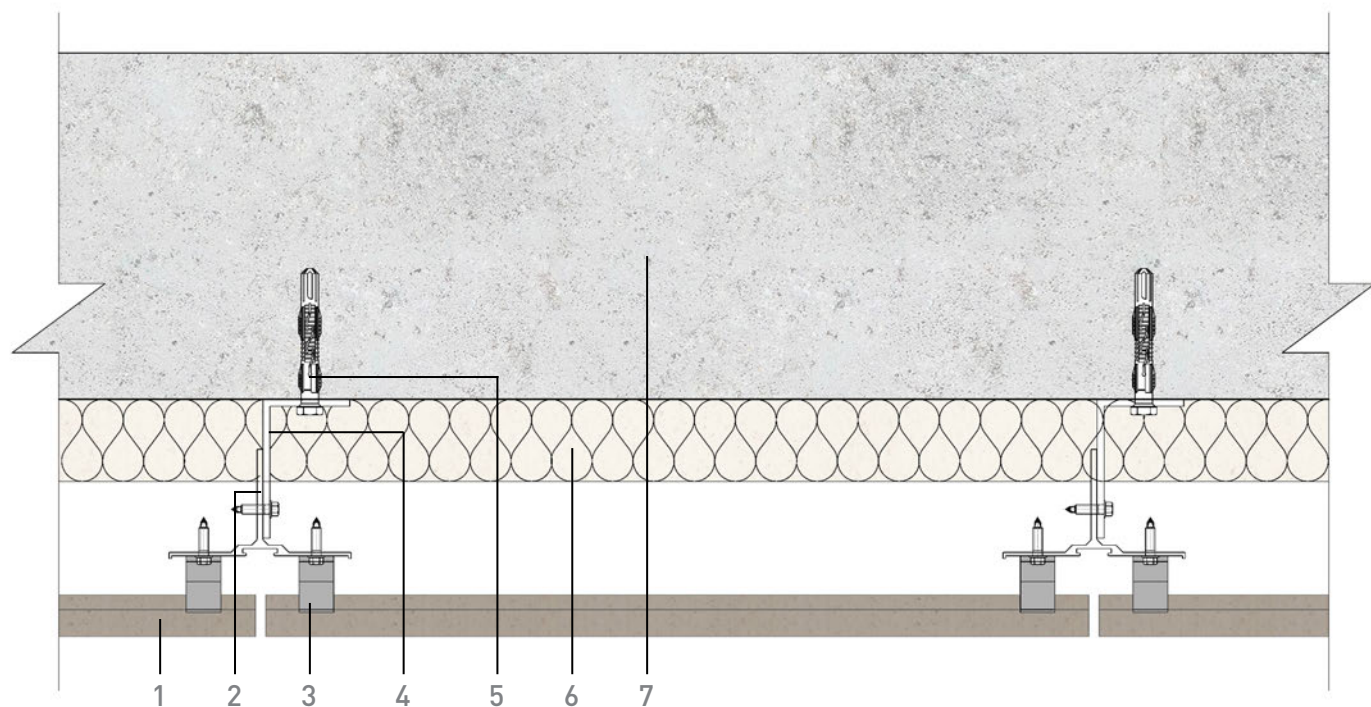

- | | |
|--|---------------------------------|
| 1. Tempio tile
Pieza Tempio | 5. Anchorage
Anclaje |
| 2. Vertical T profile
Perfil T vertical | 6. Insulating layer
Aislante |
| 3. Clip
Grapa | 7. Wall
Muro |
| 4. Bracket
Ménsula | |

FS SYSTEM

Horizontal section
Sección horizontal

tempio®

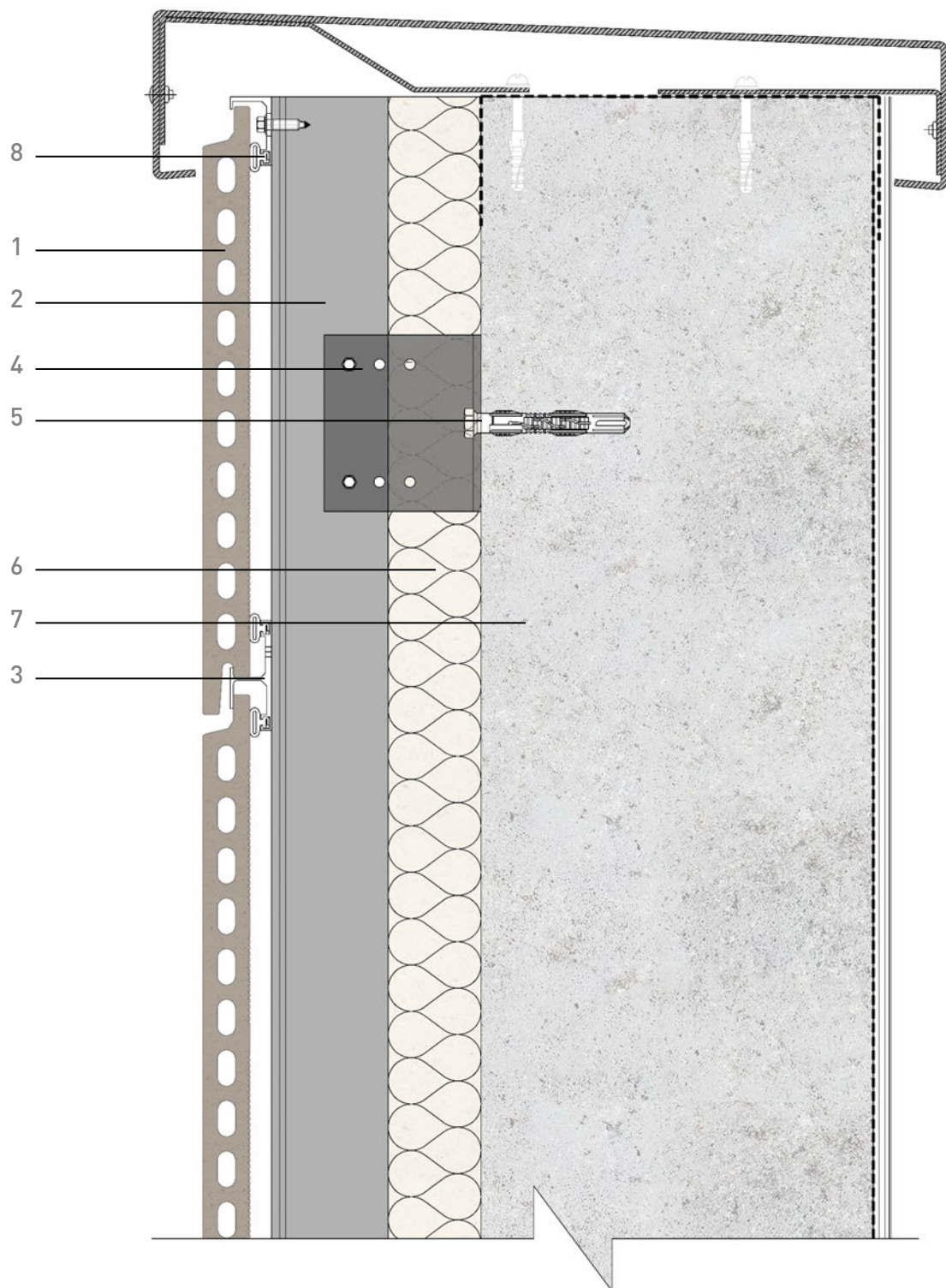

1. Tempio tile
Pieza Tempio

2. Vertical T profile
Perfil T vertical

3. Clip
Clip

4. Bracket
Ménsula

5. Anchorage
Anclaje

6. Insulating layer
Aislante

7. Wall
Muro

8. Termination clip
Clip de terminación

FS SYSTEM

Metallic coping

Coronación metálica

tempio®

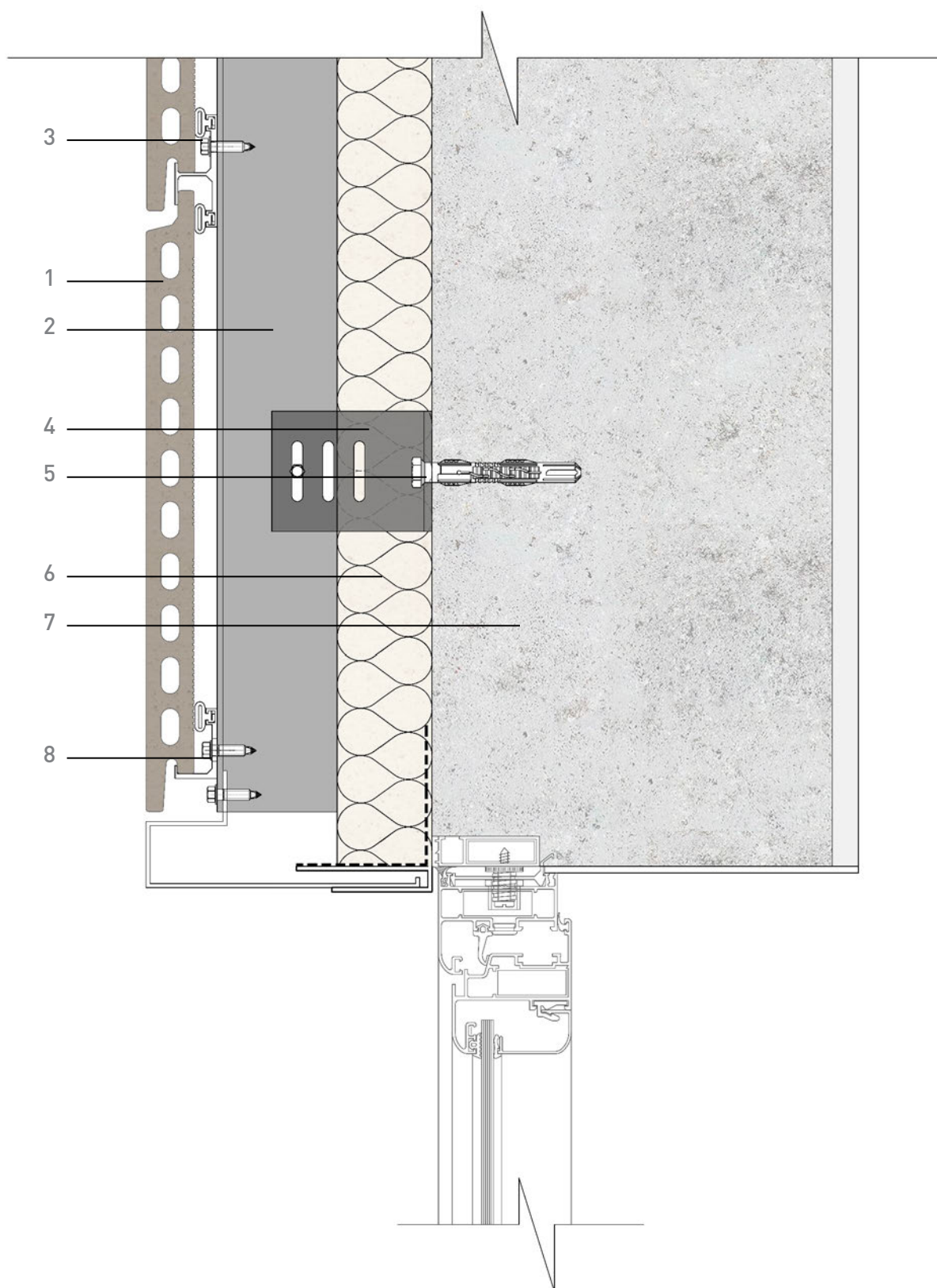

1. Tempio tile
Pieza Tempio

2. Vertical T profile
Perfil T vertical

3. Clip
Clip

4. Bracket
Ménsula

5. Anchorage
Anclaje

6. Insulating layer
Aislante

7. Wall
Muro

8. Termination clip
Clip de terminación

FS SYSTEM

Metallic lintel
Dintel metálico

tempio®

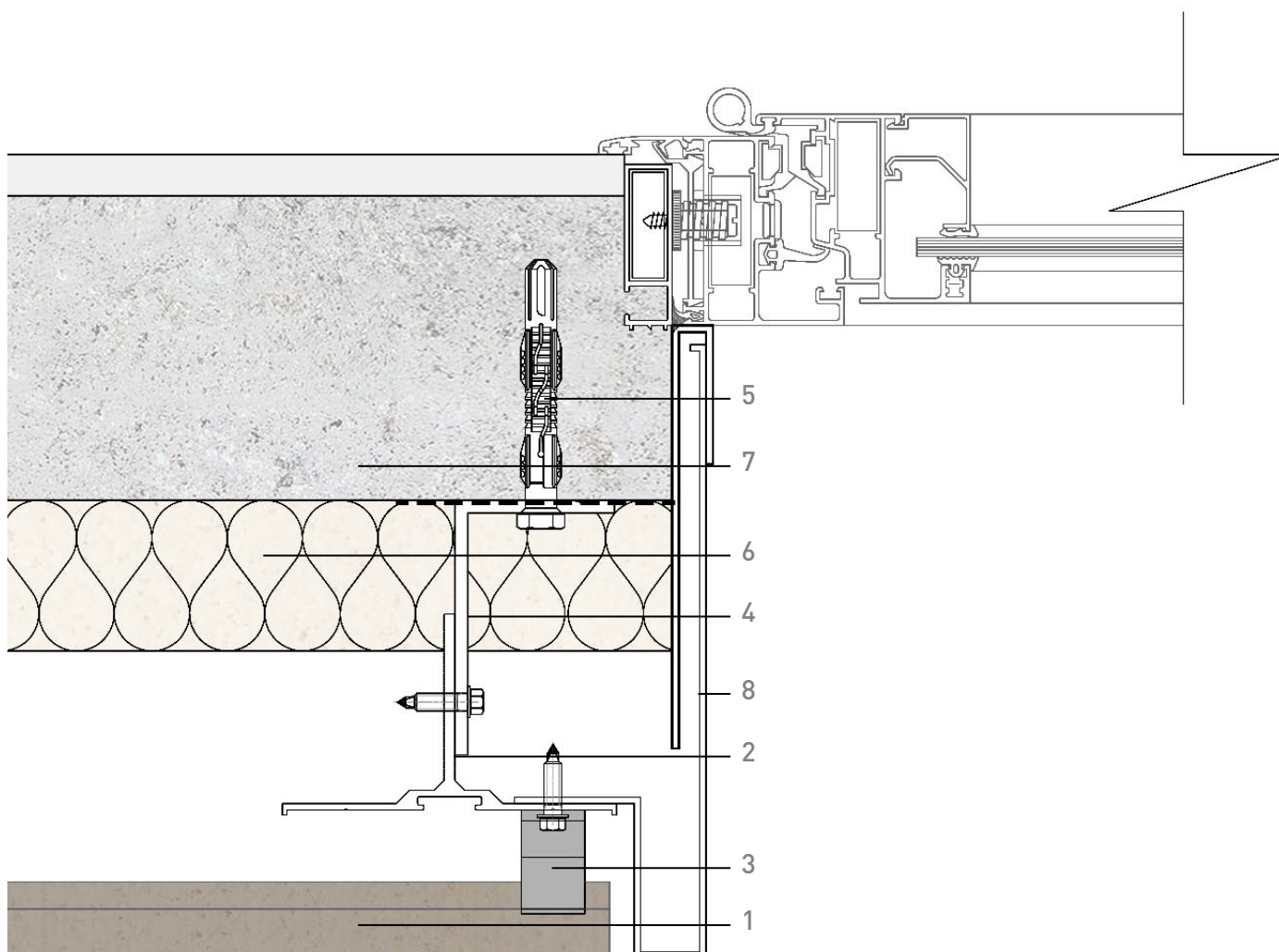

- | | | |
|--|---------------------------------|----------------------------------|
| 1. Tempio tile
Pieza Tempio | 4. Bracket
Ménsula | 7. Wall
Muro |
| 2. Vertical T profile
Perfil T vertical | 5. Anchorage
Anclaje | 8. Metal sheet
Chapa de metal |
| 3. Clip
Grapa | 6. Insulating layer
Aislante | |

FS SYSTEM

Window jamb
Jamba metálica

tempio®

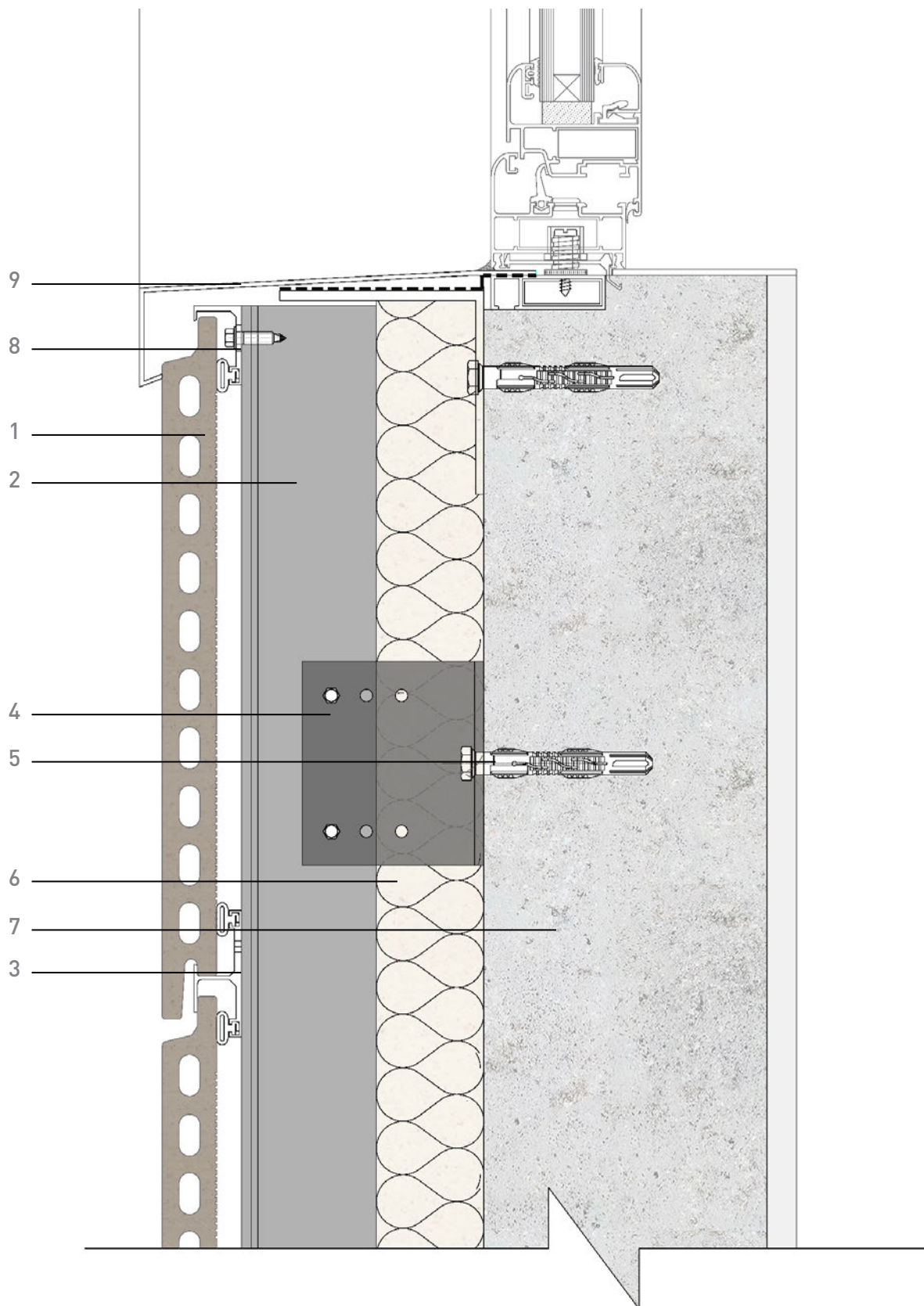

1. Tempio tile
Pieza Tempio

2. Vertical T profile
Perfil T vertical

3. Clip
Grapa

4. Bracket
Ménsula

5. Anchorage
Anclaje

6. Insulating layer
Aislante

7. Wall
Muro

8. Termination clip
Clip de terminación

9. Metal sheet
Chapa de metal

FS SYSTEM

Metallic sill

Vierteaguas metálico

tempio®

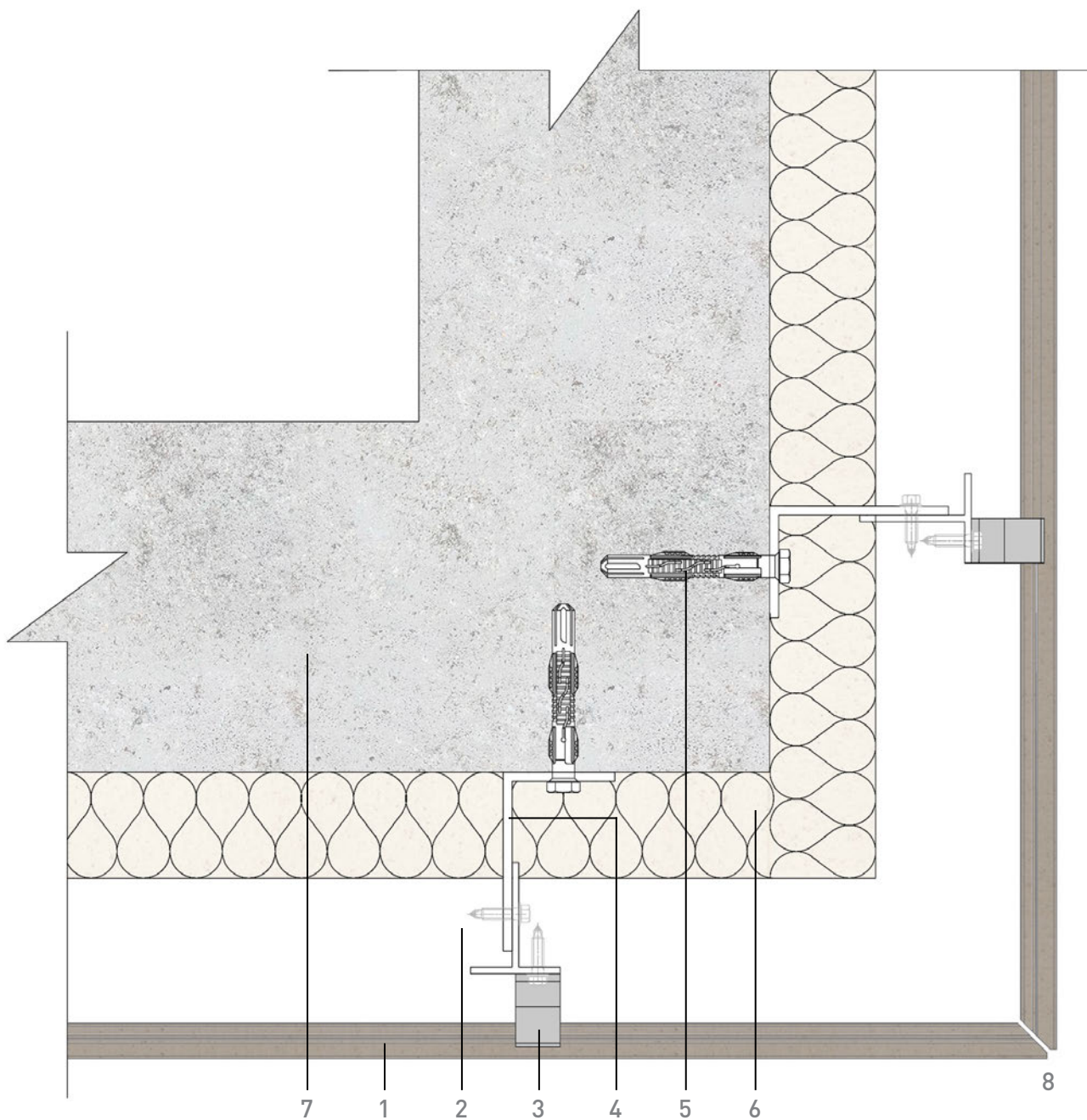

1. Tempio tile
Pieza Tempio

2. Vertical T profile
Perfil T vertical

3. Clip
Grapa

4. Bracket
Ménsula

5. Anchorage
Anclaje

6. Insulating layer
Aislante

7. Wall
Muro

8. Mitter cut
Corte en inglete

FS SYSTEM

Exterior corner

Esquina exterior

tempio®

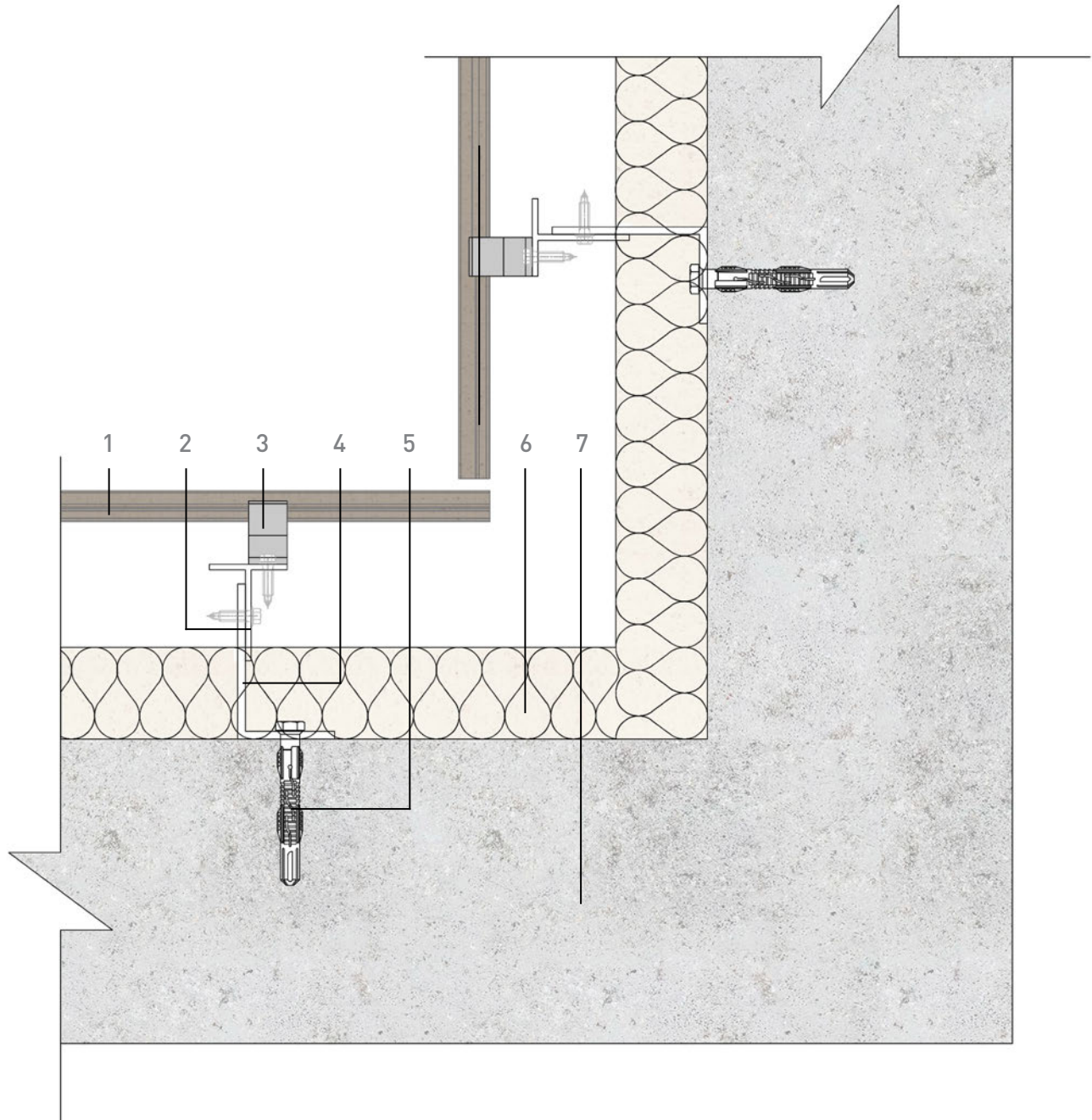

1. Tempio tile
Pieza Tempio

2. Vertical T profile
Perfil T vertical

3. Clip
Grapa

4. Bracket
Ménsula

5. Anchorage
Anclaje

6. Insulating layer
Aislante

7. Wall
Muro

FS SYSTEM

Interior corner

Esquina interior

tempio®

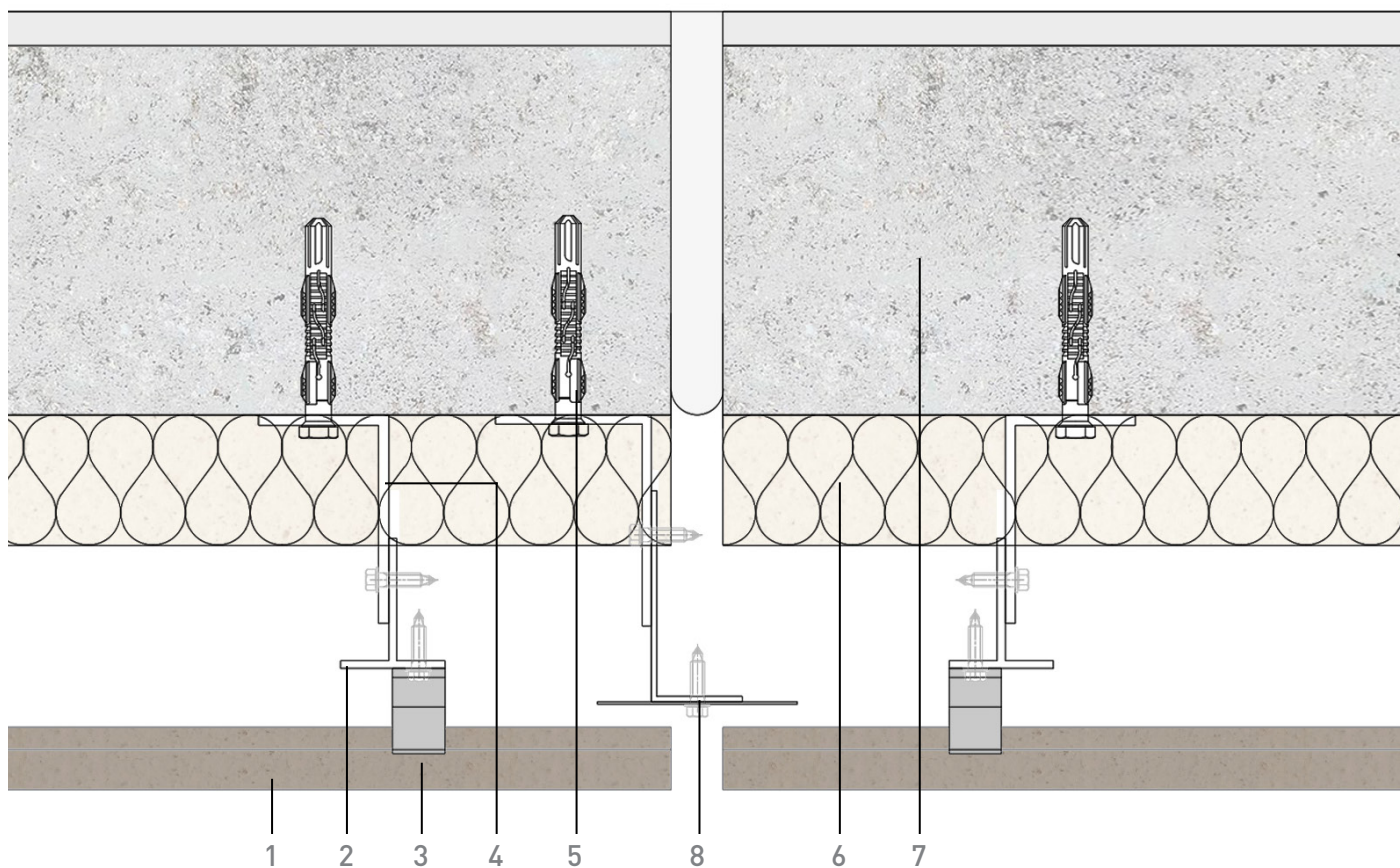

- | | |
|--|----------------------------------|
| 1. Tempio tile
Pieza Tempio | 5. Anchorage
Anclaje |
| 2. Vertical T profile
Perfil T vertical | 6. Insulating layer
Aislante |
| 3. Clip
Grapa | 7. Wall
Muro |
| 4. Bracket
Ménsula | 8. Metal sheet
Chapa de metal |

FS SYSTEM

Dilatation joint

Junta de dilatación

tempio®

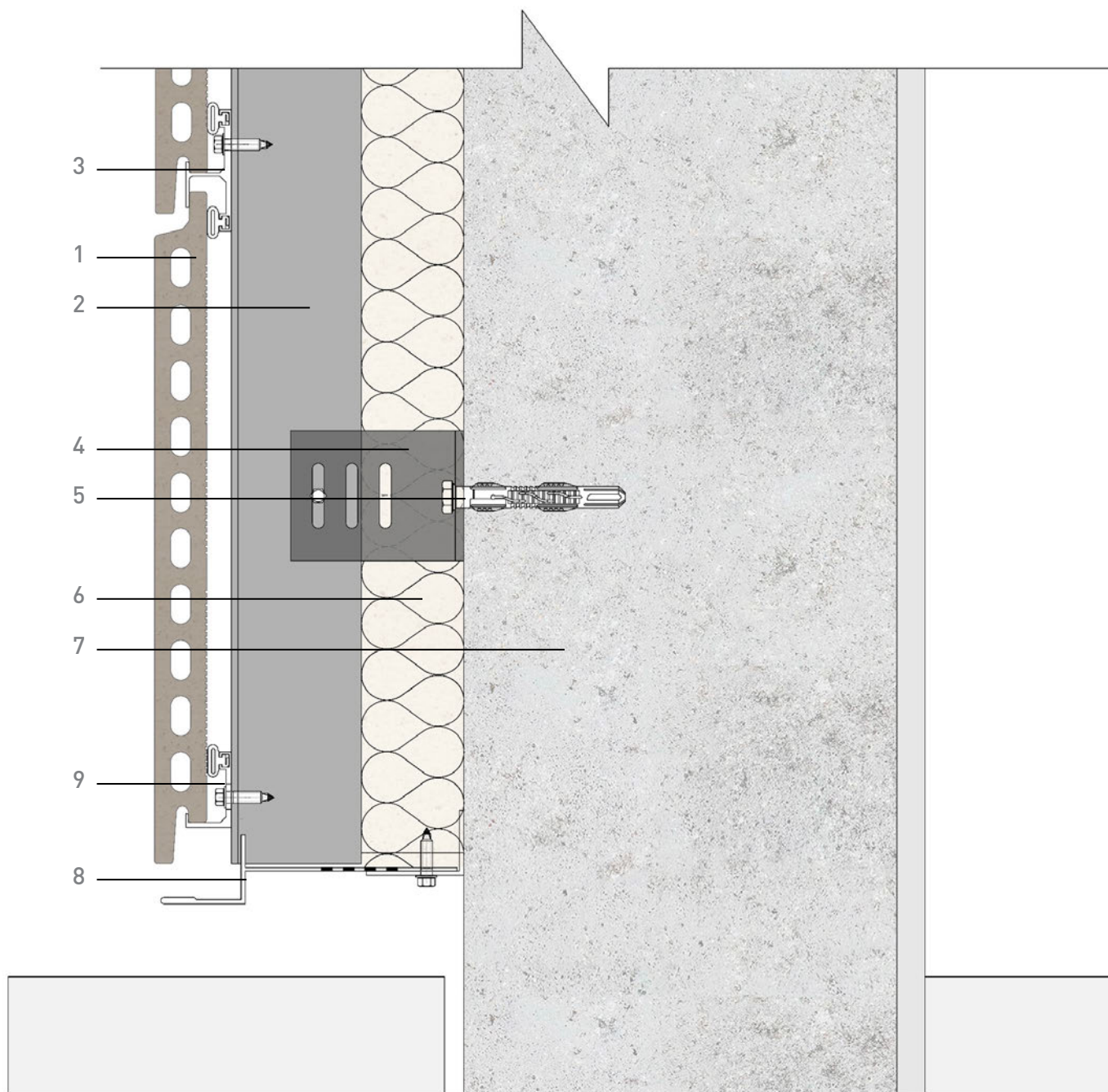

1. Tempio tile
Pieza Tempio

2. Vertical T profile
Perfil T vertical

3. Intermediate clip
Clip intermedio

4. Bracket
Ménsula

5. Anchorage
Anclaje

6. Insulating layer
Aislante

7. Wall
Muro

8. Perforated metal profile
Chapa metal perforada

9. Termination clip
Clip de terminación

FS SYSTEM

Termination

Terminación

tempio®

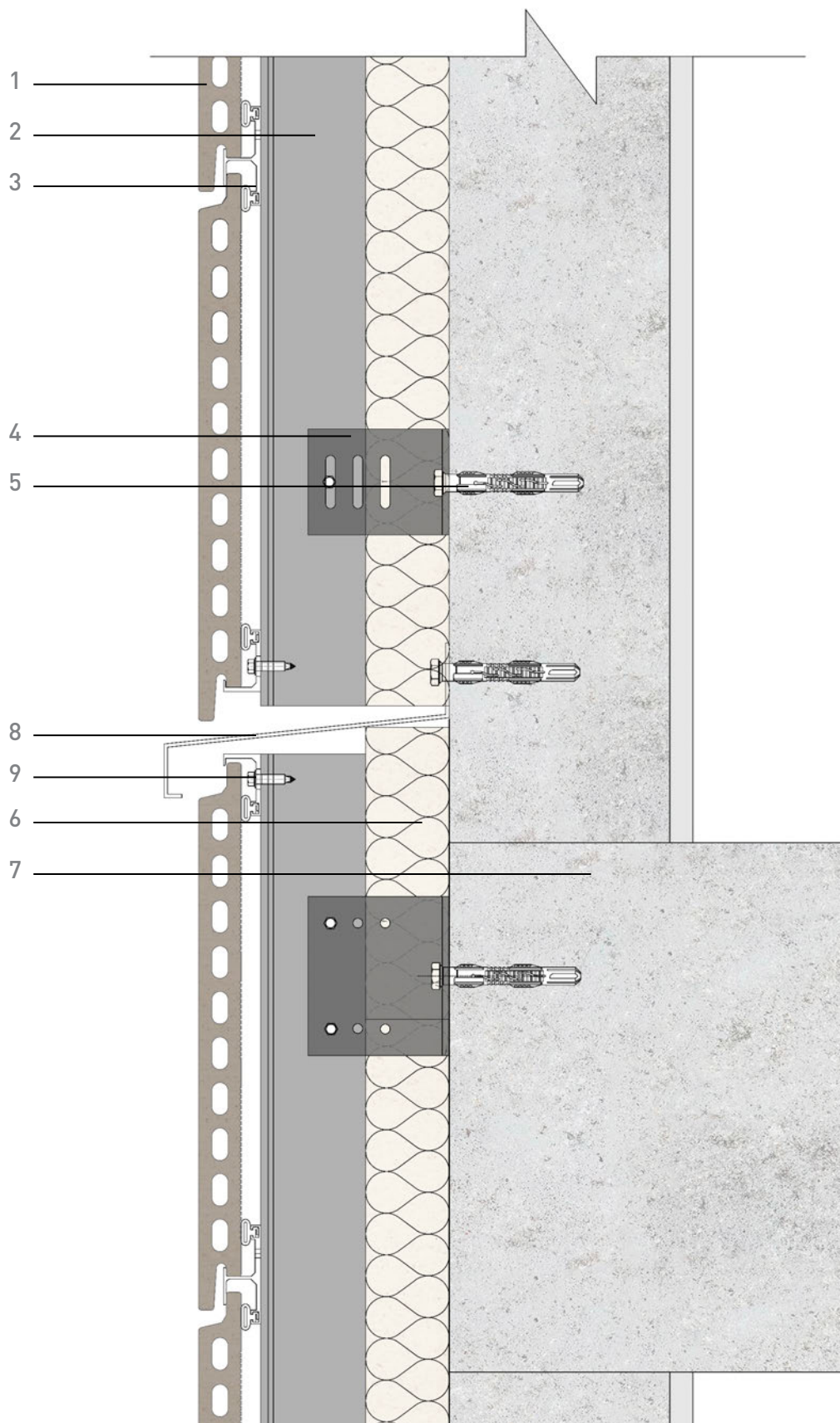

1. Tempio tile
Pieza Tempio

2. Vertical T profile
Perfil T vertical

3. Intermediate clip
Clip intermedio

4. Bracket
Ménsula

5. Anchorage
Anclaje

6. Insulating layer
Aislante

7. Wall
Muro

8. Metal profile
Chapa metal

9. Termination clip
Clip de terminación

FS SYSTEM

Cortafuegos

Firewall

tempio®

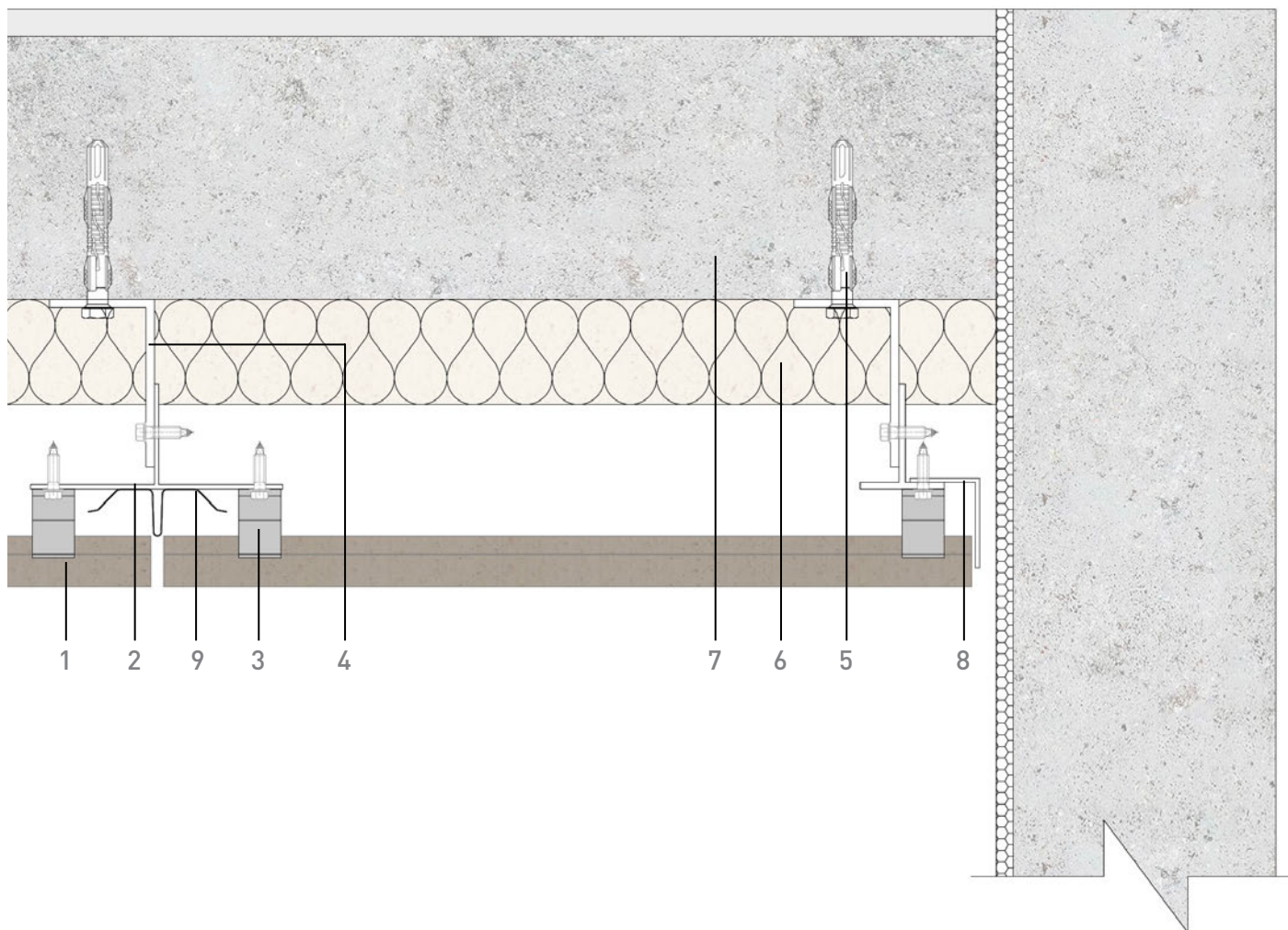

- | | | |
|--|---------------------------------|--|
| 1. Tempio tile
Pieza Tempio | 4. Bracket
Ménsula | 7. Wall
Muro |
| 2. Vertical T profile
Perfil T vertical | 5. Anchorage
Anclaje | 8. Finishing profile
Angular de terminación |
| 3. Clip
Grapa | 6. Insulating layer
Aislante | 9. Joint profile
Perfil de junta |

FK SYSTEM

Side termination
Terminación lateral

tempio®

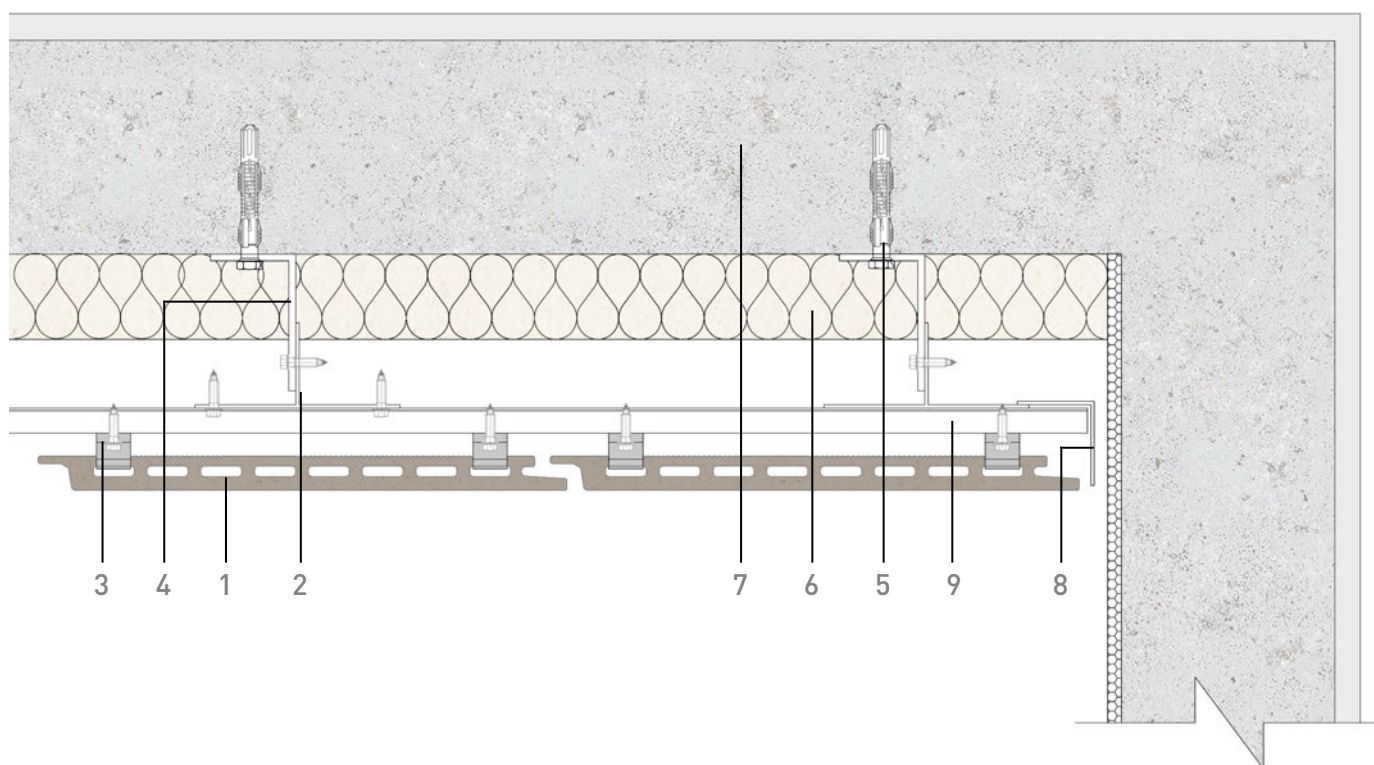

- | | | |
|--|---------------------------------|-------------------------------------|
| 1. Tempio tile
Pieza Tempio | 4. Bracket
Ménsula | 7. Wall
Muro |
| 2. Vertical T profile
Perfil T vertical | 5. Anchorage
Anclaje | 8. Metal sheet
Chapa de metal |
| 3. Clip
Grapa | 6. Insulating layer
Aislante | 9. Hat list profile
Perfil Omega |

FS SYSTEM

Side termination

Terminación lateral

tempio®

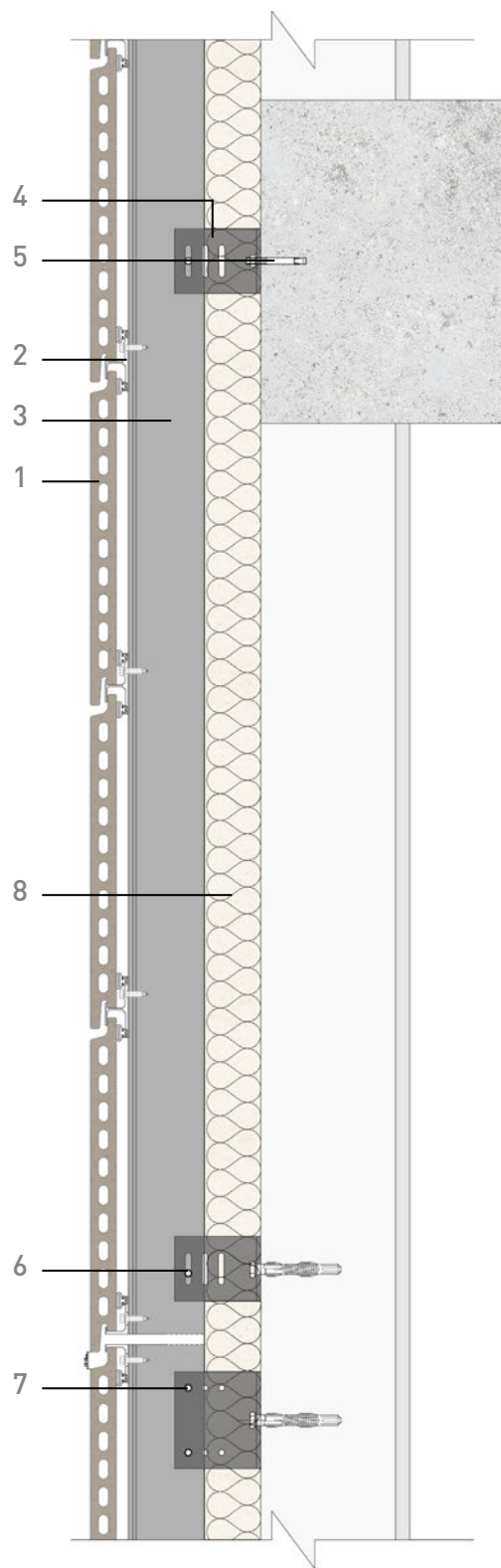

A. Vertical section
Sección vertical

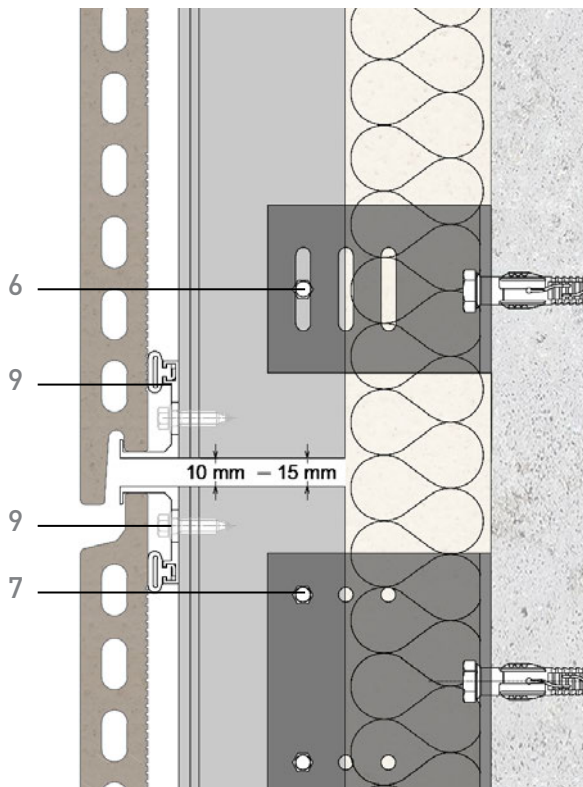

B. Detail of mounting fixings
Detalle de montaje de fijaciones

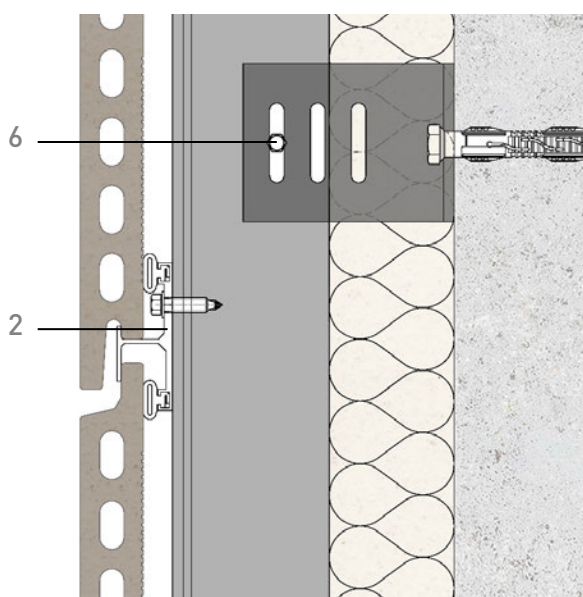

C. Placement in vertical profile
Colocación en perfil vertical

- | | | |
|--------------------------------|---|--|
| 1. Tempio tile
Pieza Tempio | 5. Anchorage
Anclaje | 9. Termination clip
Clip de terminación |
| 2. Clip
Grapa | 6. Fixed to sliding point
Fijación corredera | |
| 3. Main T profile
Perfil T | 7. Fixed point
Fijación fija | |
| 4. Bracket
Ménsula | 8. Insulating layer
Aislante | |

FS SYSTEM

Fixation
Fijación

tempio®

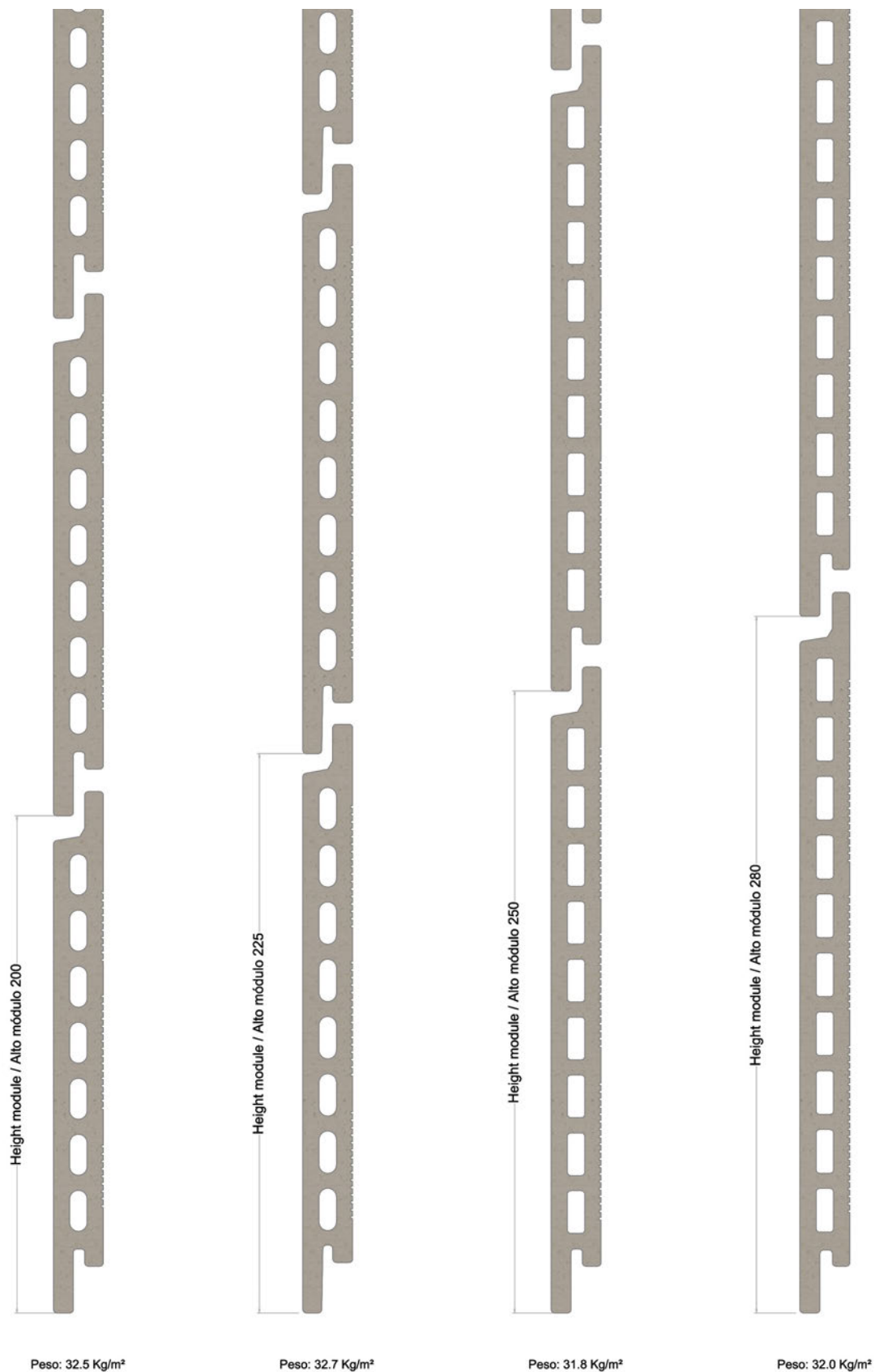

Module / Módulos:
200, 225, 250, 280

Length tile / Largo pieza:
< 1500 mm

Joint / Junta:
8-12 mm

Weight / Peso:
32,5 kg/m²
32,7 kg/m²
31,8 kg/m²
32 kg/m²

FS SYSTEM

FS-20

tempio®



Height module / Alto módulo 300

Peso: 31 Kg/m²



Height module / Alto módulo 300

Peso: 32.5 Kg/m²



Height module / Alto módulo 450

Peso: 33.0 Kg/m²



Height module / Alto módulo 500

Peso: 33.5 Kg/m²

Module / Módulos:
300a, 300b, 450, 500

Length tile / Largo pieza:
< 1500 mm

Joint / Junta:
8-12 mm

Weight / Peso:
31 kg/m²
32,5 kg/m²
33 kg/m²
33,5 kg/m²

FS SYSTEM

FS-20

tempio®

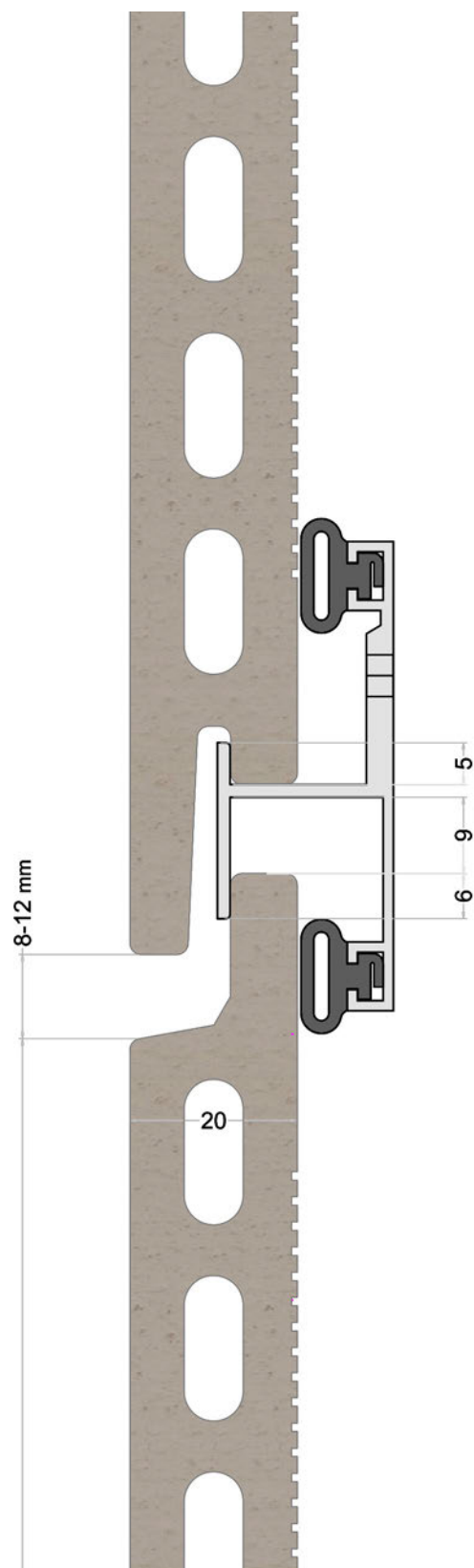
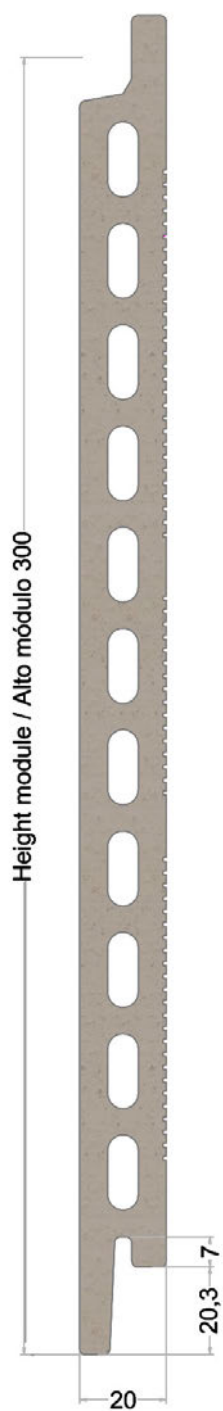

FS SYSTEM

FS-20

Module / Módulo:
300

Weight / Peso:
32 kg/m²

Joint / Junta:
8-12 mm

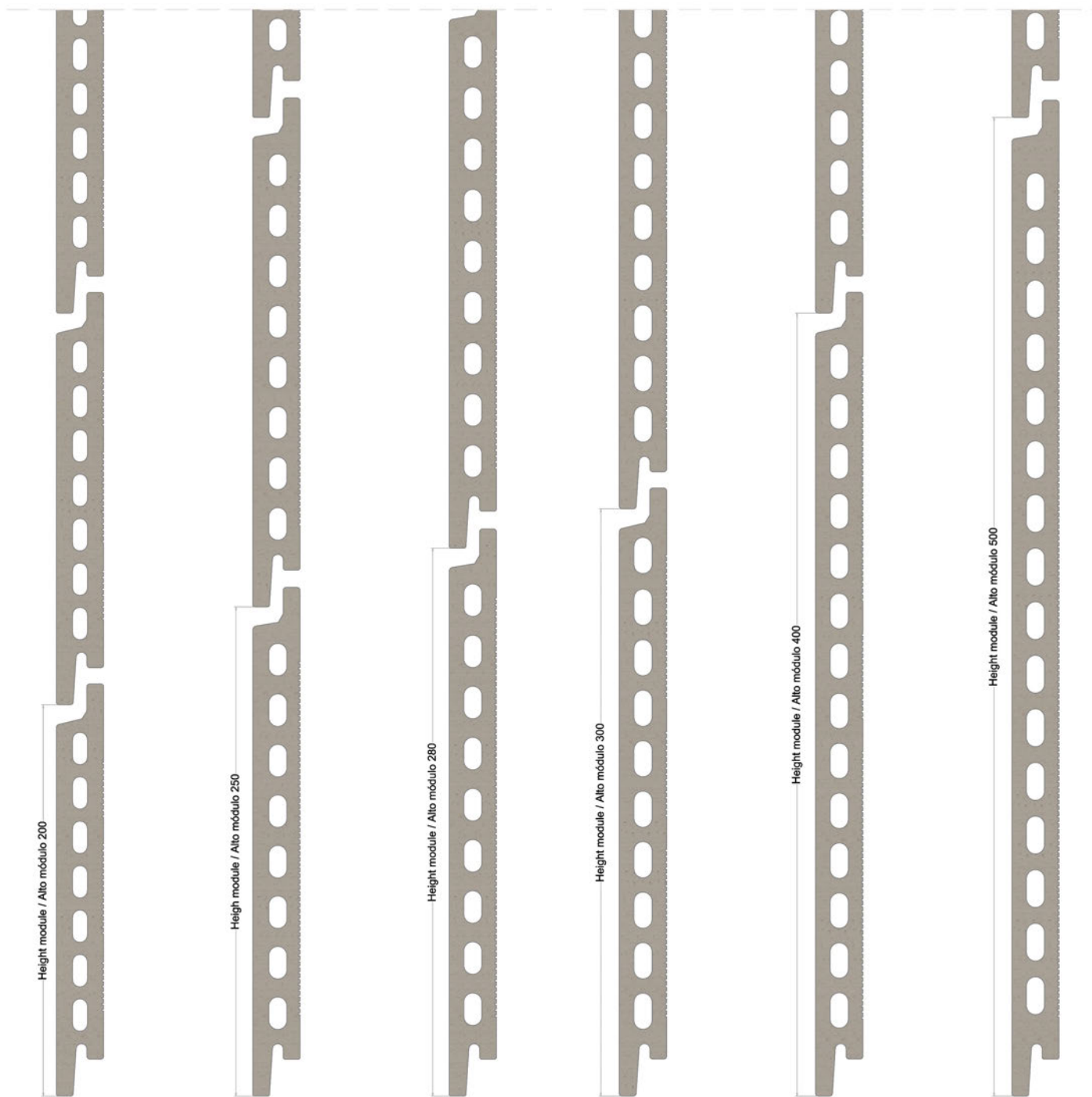

Module / Módulos:
200, 250, 280, 300,
400, 500

Length tile / Largo pieza:
< 1500 mm

Weight / Peso:
42 kg/m²

Joint / Junta:
8-12 mm

FS SYSTEM

FS-24

tempio®

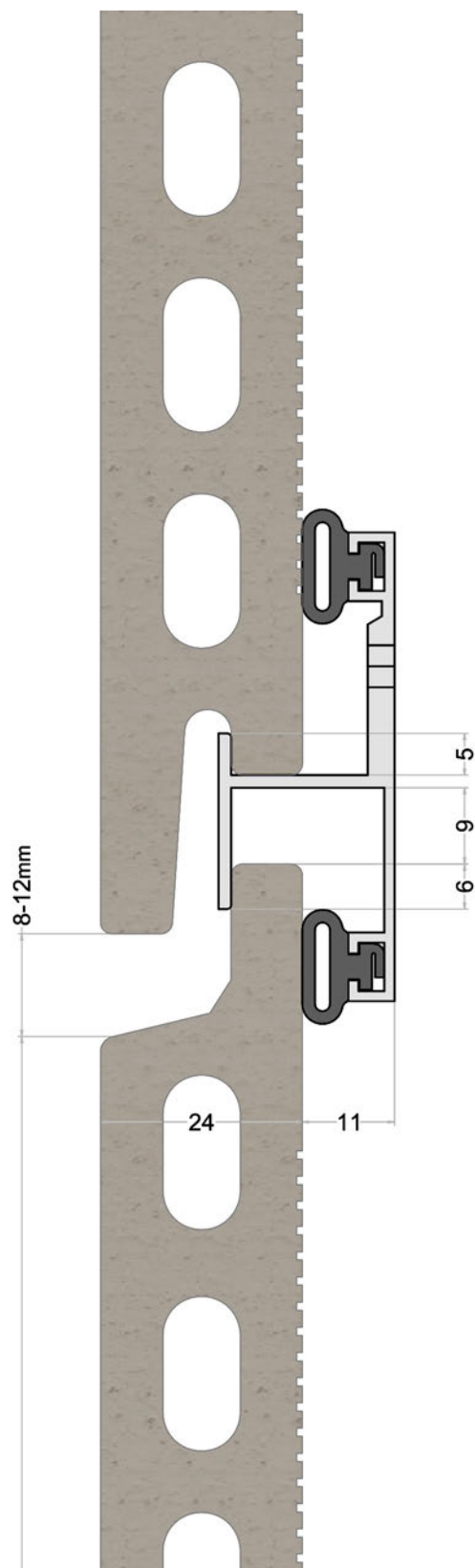
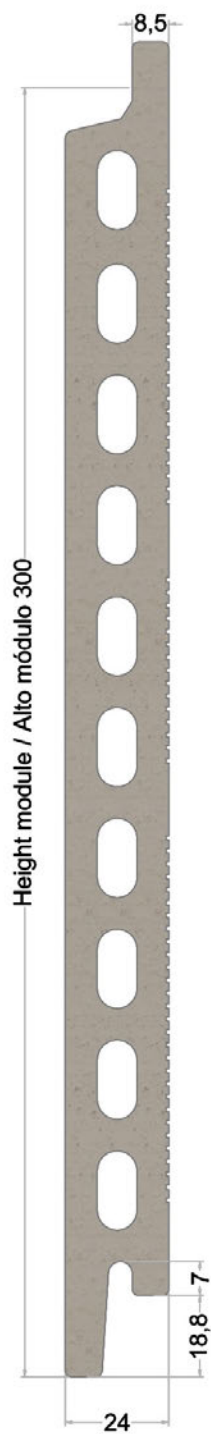

FS SYSTEM

FS-24

Module / Módulo:
300

Weight / Peso:
42 kg/m²

Joint / Junta:
8-12 mm

tempio®

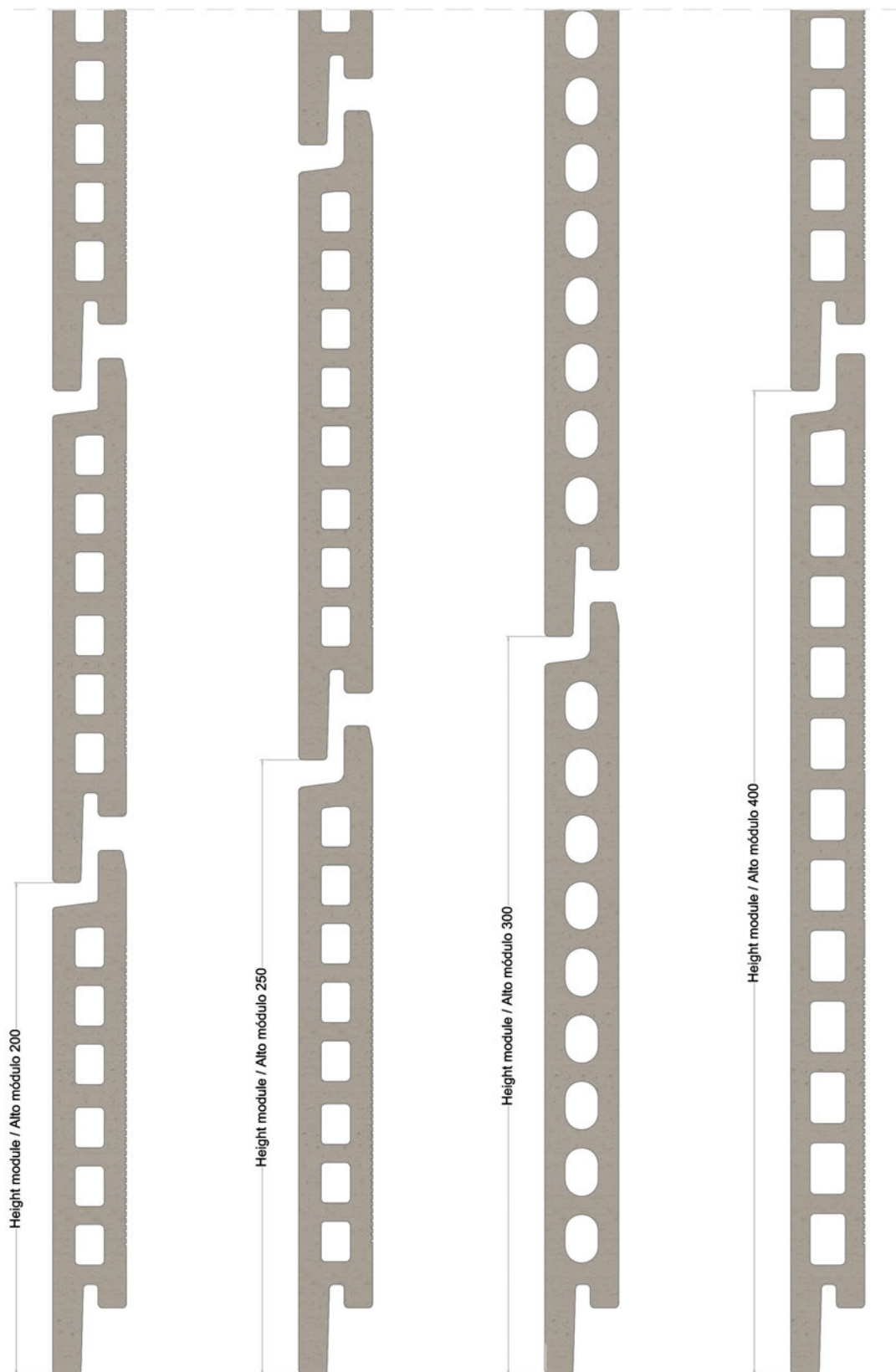

Module / Módulos:
200, 250, 300, 400

Length tile / Largo pieza:
< 1500 mm

Weight / Peso:
48 kg/m²

Joint / Junta:
8-12 mm

FS SYSTEM

FS-30

tempio®

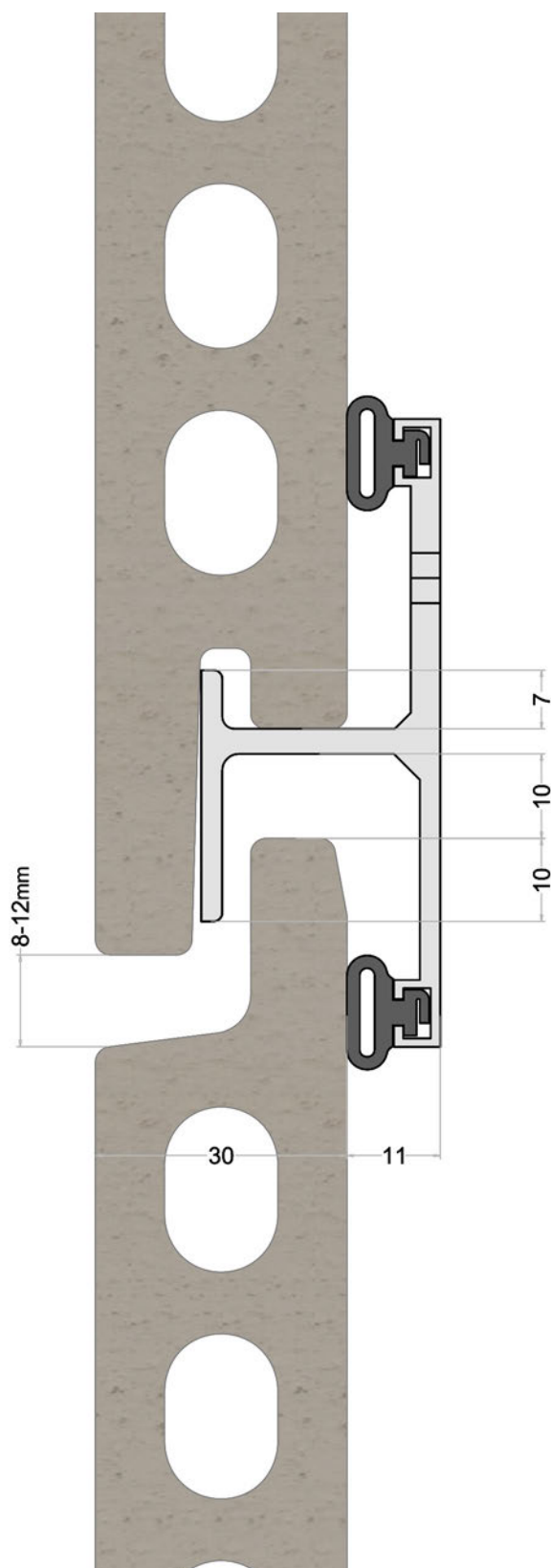
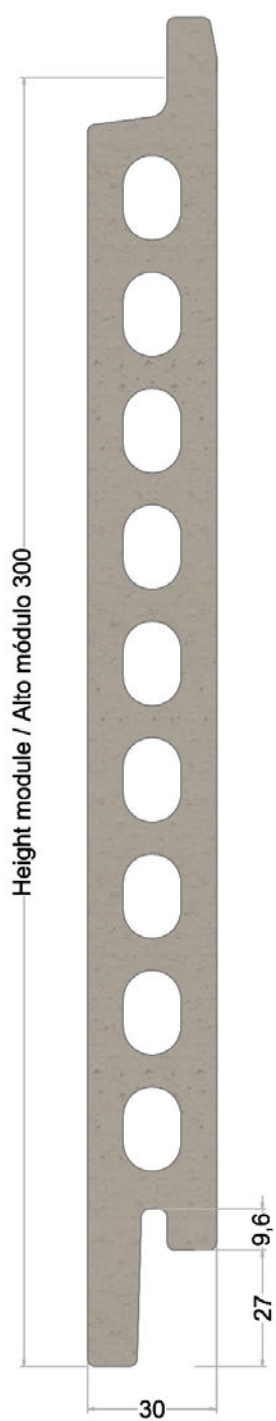

FS SYSTEM

FS-30

Module / Módulo:
300

Weight / Peso:
48 kg/m²

Joint / Junta:
8-12 mm

tempio®

2019

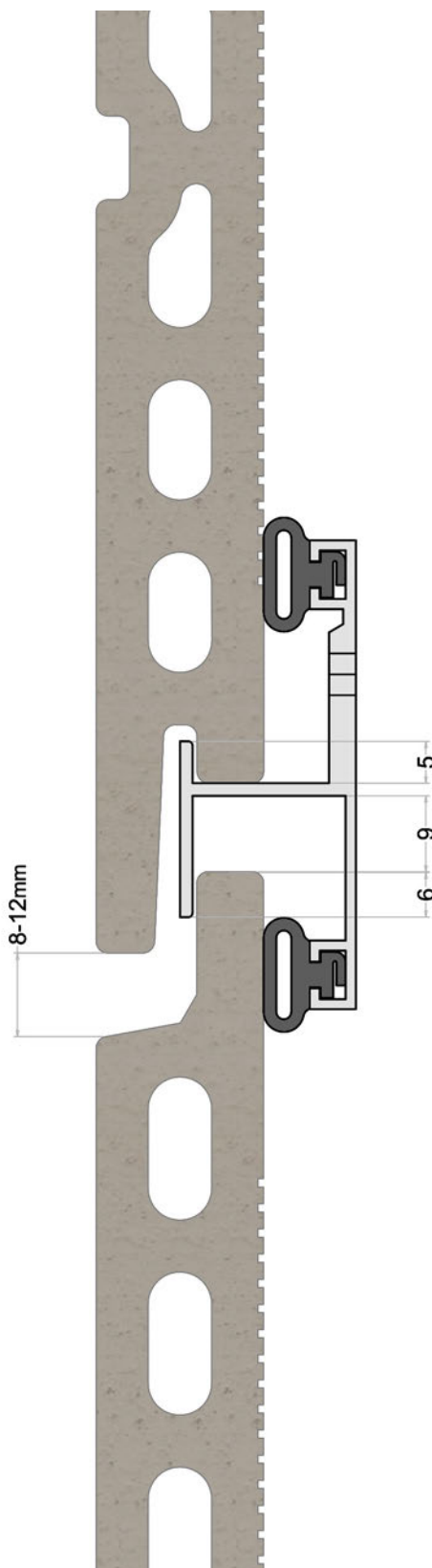
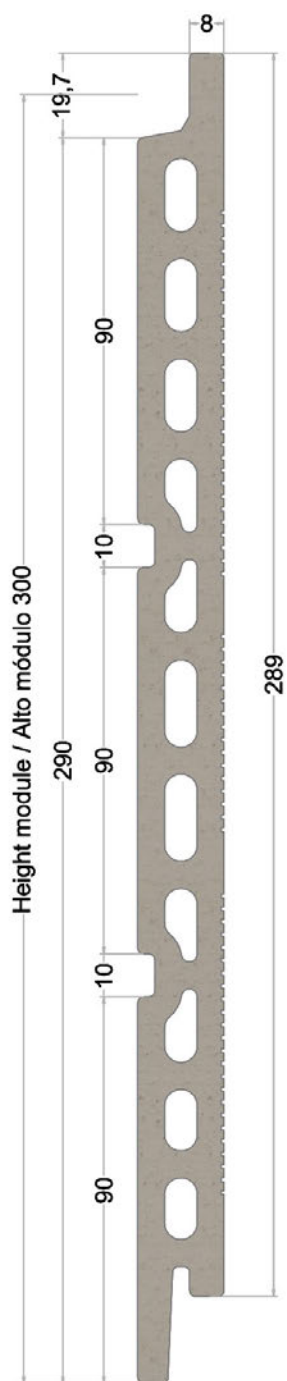

FS SYSTEM

FS-L2/20

Module / Módulo
300

Weight / Peso
31,7 kg/m²

Joint / Junta:
8-12 mm

tempio®

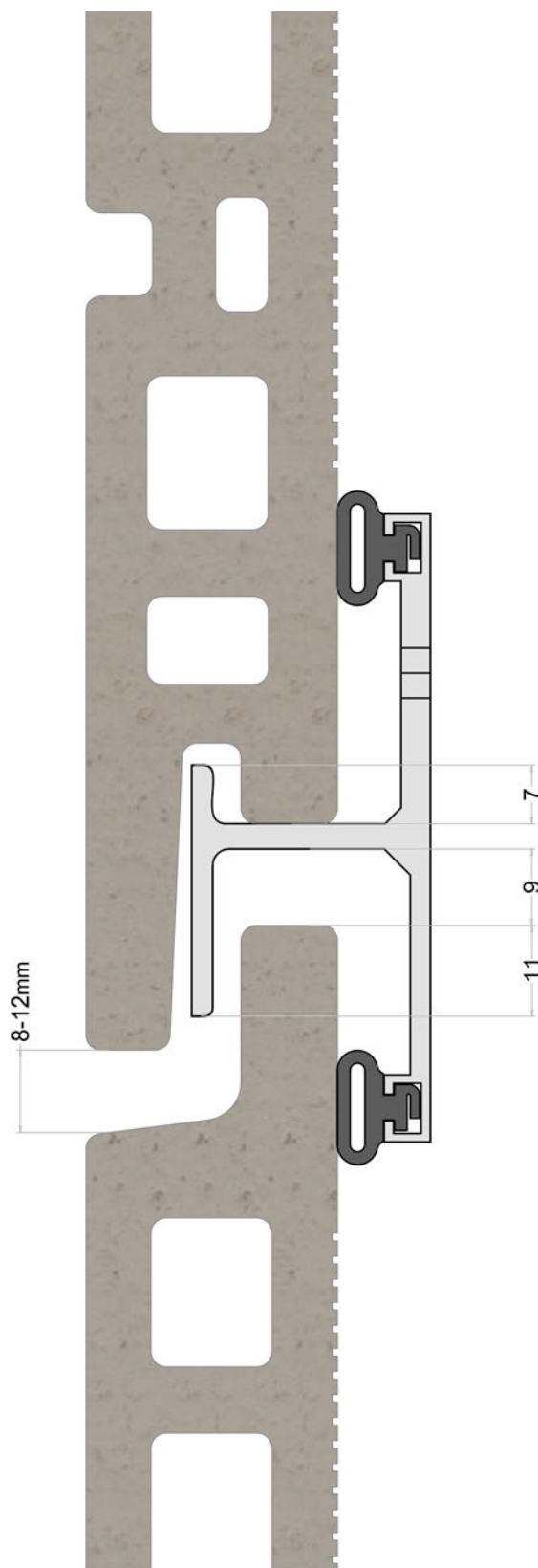
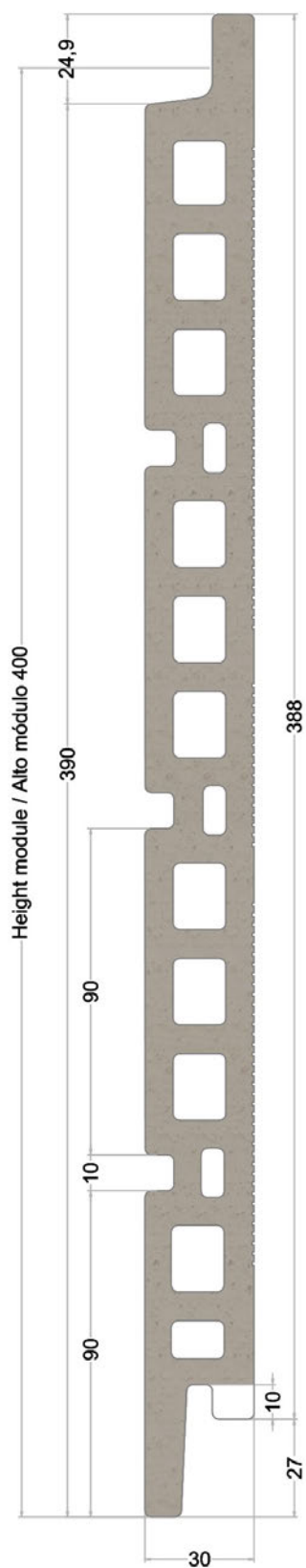

FS SYSTEM

FS-L3/30

Module / Módulo
400

Weight / Peso
45 kg/m²

Joint / Junta:
8-12 mm

tempio®

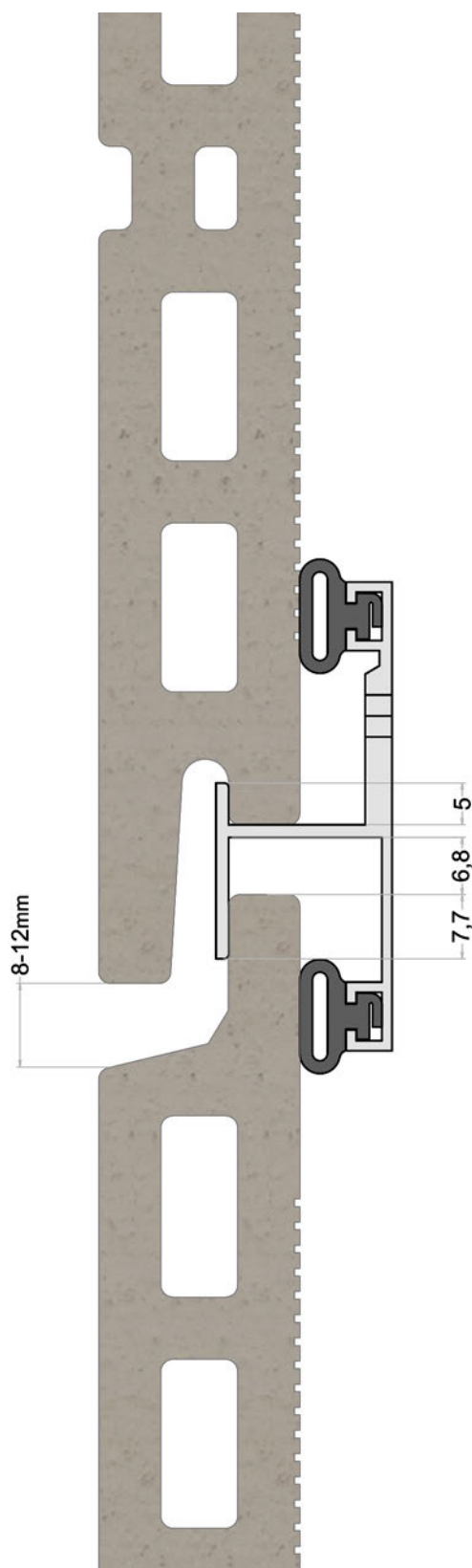
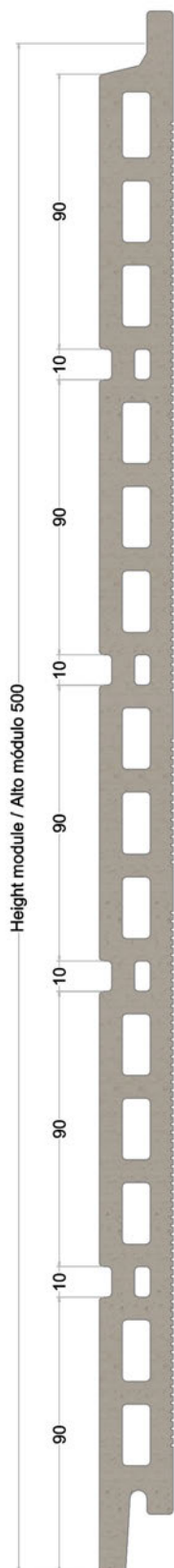

FS SYSTEM

FS-L4/24

Module / Módulo: 500 Weight / Peso: 40 kg/m² Joint / Junta: 8-12 mm

tempio®

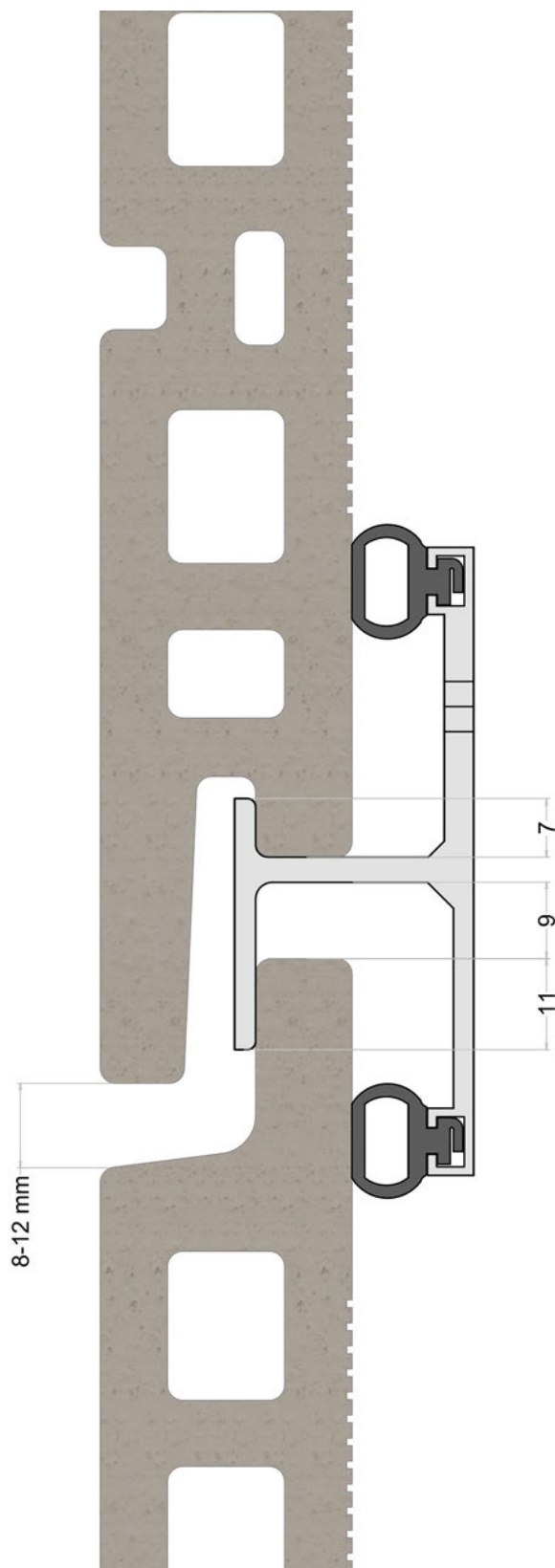
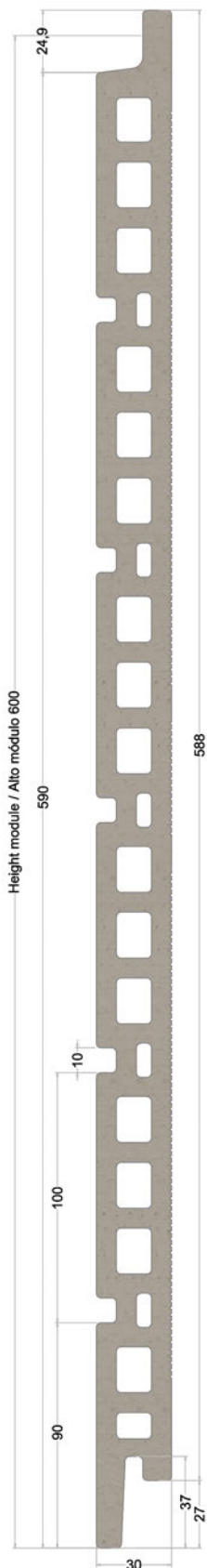

FS SYSTEM

FS-L5/30

Module / Módulo
600

Weight / Peso
45,5 kg/m²

Joint / Junta:
8-12 mm

tempio®

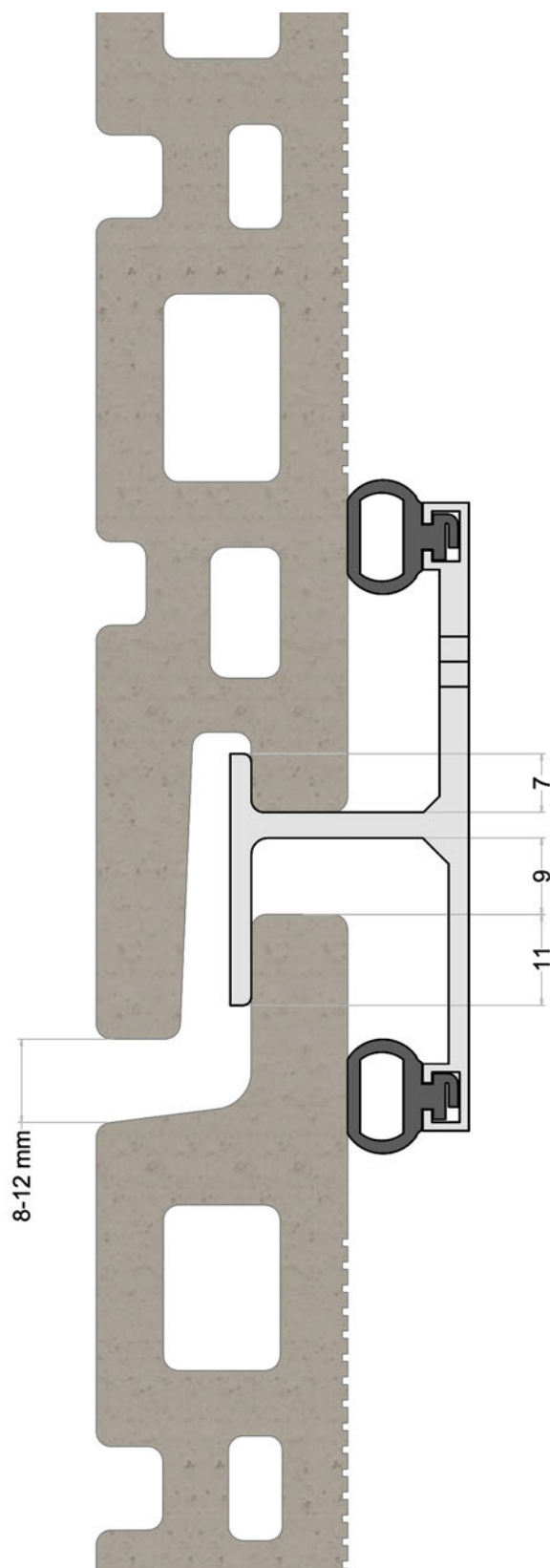
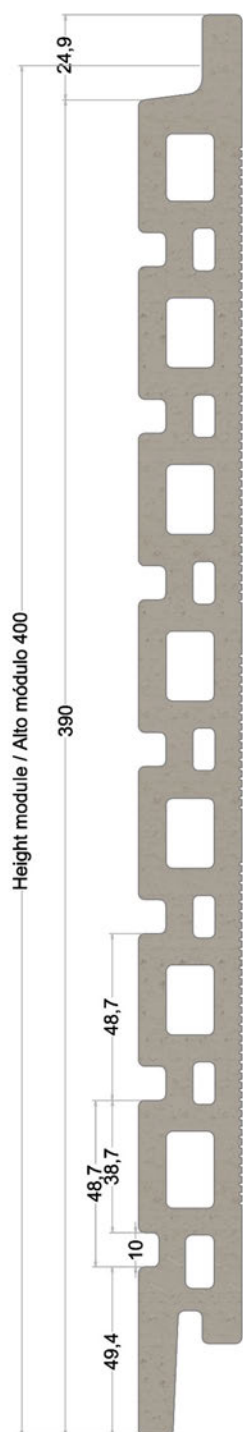

FS SYSTEM

FS-L7/30

Module / Módulo
400

Weight / Peso
44 kg/m²

Joint / Junta:
8-12 mm

tempio®

2019

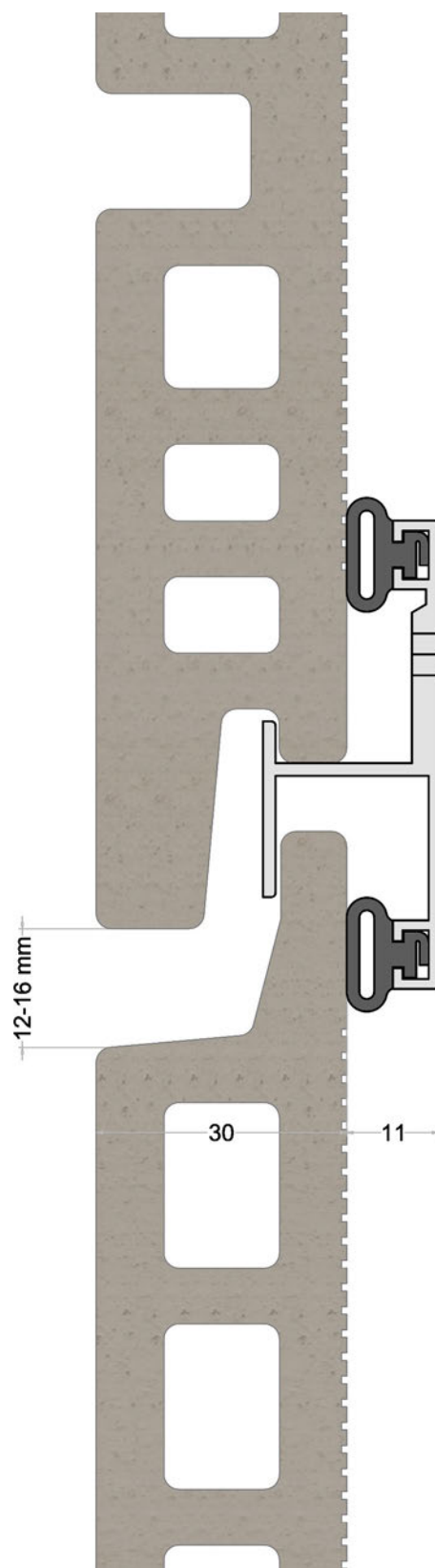
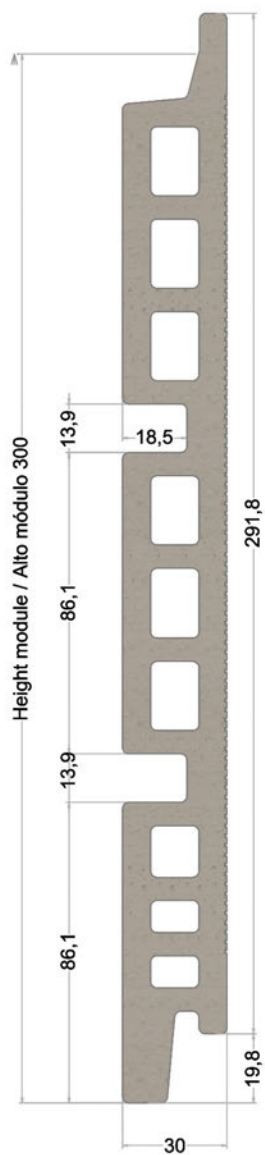

FS SYSTEM

FS-LP 2/30

Module / Módulo:
300

Weight / Peso:
42 kg/m²

Joint / Junta:
12-16 mm

tempio®

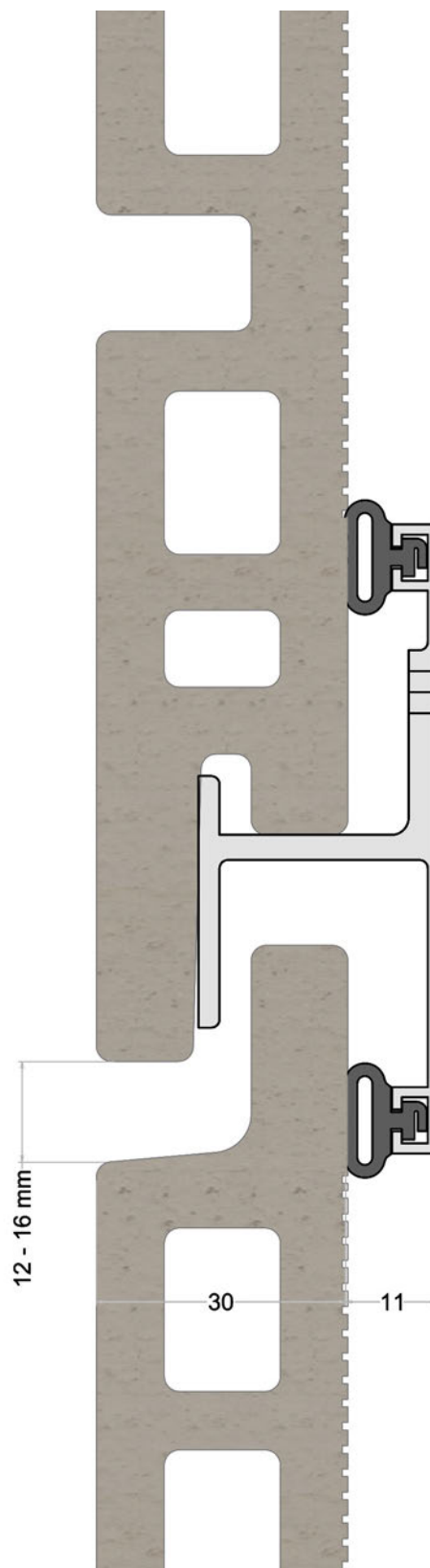
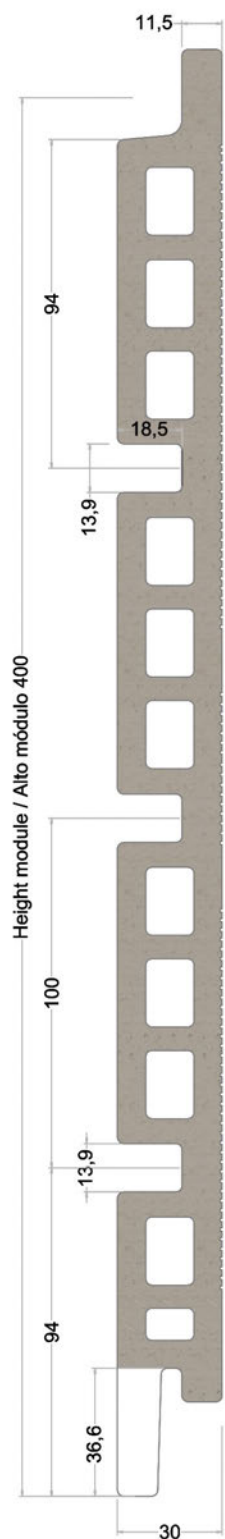

FS SYSTEM

FS-LP 3/30

Module / Módulo
400

Weight / Peso
42 kg/m²

Joint / Junta:
12-16 mm

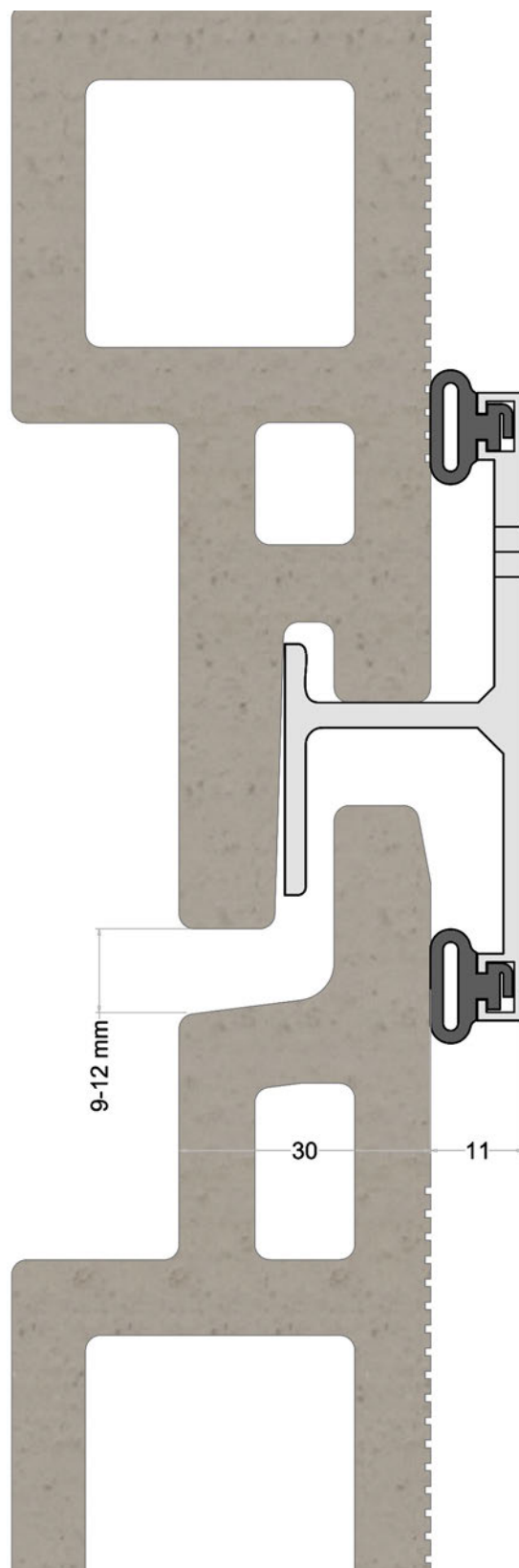
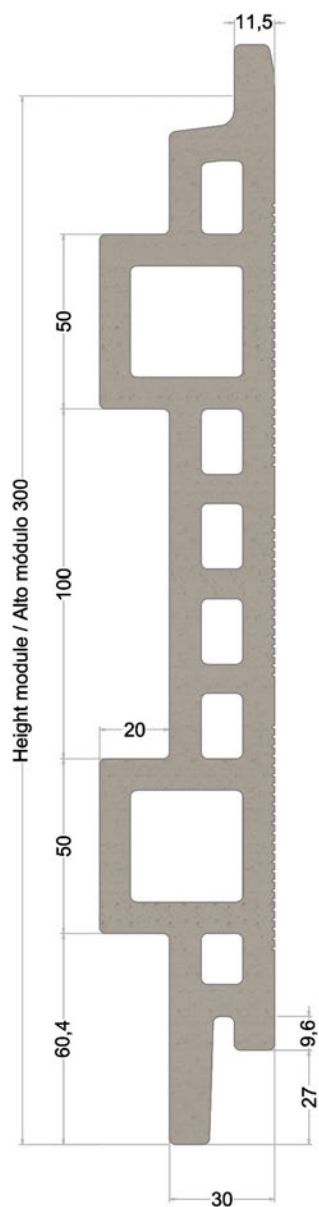

FS SYSTEM

FS-2B 5/30

Module / Módulo
300

Weight / Peso
52 kg/m²

Joint / Junta:
8-12 mm

tempio®

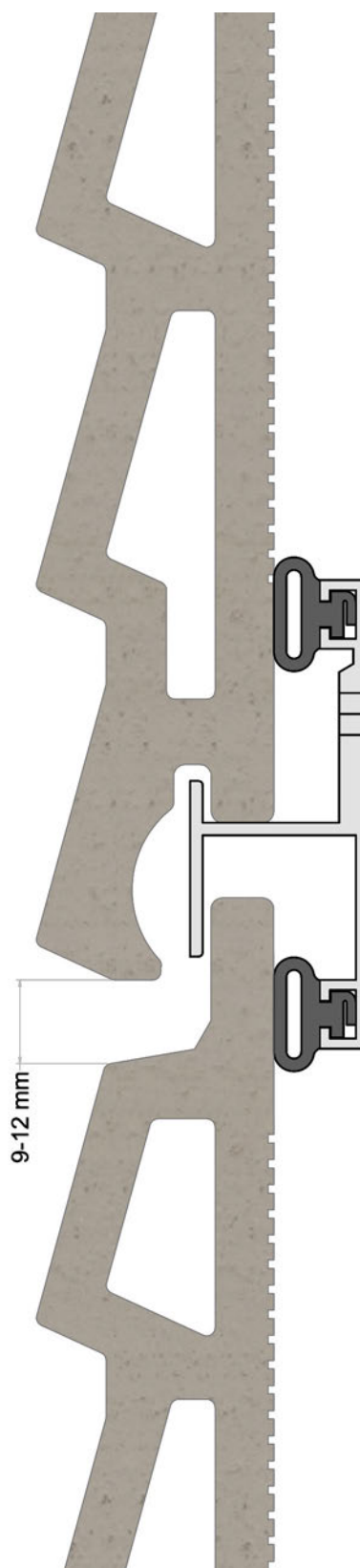
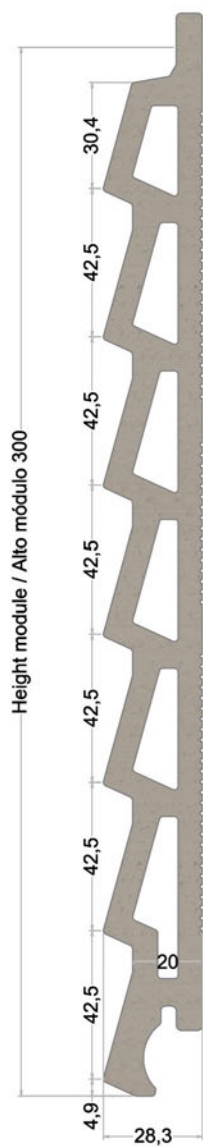

FS SYSTEM

FS-T 7/28

Module / Módulo
300

Weight / Peso
37 kg/m²

Joint / Junta:
8-12 mm

tempio®